



# Simcenter 集成的多学科 仿真平台介绍

西门子全新一代多学科3D仿真平台

数字化

自动化

电气化

350.000  
员工



“将产品设计，仿真与验证集成现在是我们  
的当务之急。”



➤ 20亿美元  
投资于仿真

Chuck Grindstaff, CEO  
Siemens DF PL – Siemens PLM Software

SIEMENS  
*Ingenuity for life*

# 继续我们的工业软件开发战略 提供无与伦比的设计，仿真与测试解决方案

收购年份

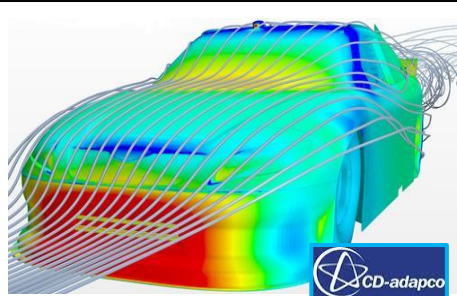
2007	三维设计		<p><b>CAD软件 NX 设计, Nastran and 产品生命周期软件Teamcenter</b></p> <ul style="list-style-type: none"> <li>▪ 在同一协同环境，优化和加速产品开发流程</li> <li>▪ 包含同一现代化的，多学科的CAE环境</li> <li>▪ Teamcenter作为协同平台，能实现全价值链连续的数据管理</li> </ul>
2012	闭环的性能分析		<p><b>仿真与测试: LMS Virtual.Lab, Imagine.Lab, Test.Lab, Samtech</b></p> <ul style="list-style-type: none"> <li>▪ 功能仿真: 一维跨学科仿真, 如机械和电气, 混合动力汽车燃油经济性和续航里程的仿真</li> <li>▪ <b>三维力学性能仿真:</b> 如强度，噪声，振动</li> <li>▪ <b>测试:</b> 基于样机的解决方案(静特性和动特性)</li> </ul>
2016	领先的产品系列		<p><b>多学科的设计探索： STAR-CCM+ 及其它</b></p> <p><b>多学科的工程仿真:</b> 主要是计算流体动力学(CFD), 用于流体，热传导和流体结构耦合分析</p> <p><b>设计探索:</b> 工程仿真流程和设计优化算法，能自动驱动产品设计，如进行减重和降低成本</p>

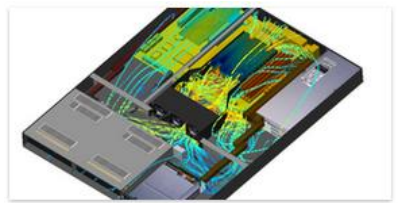
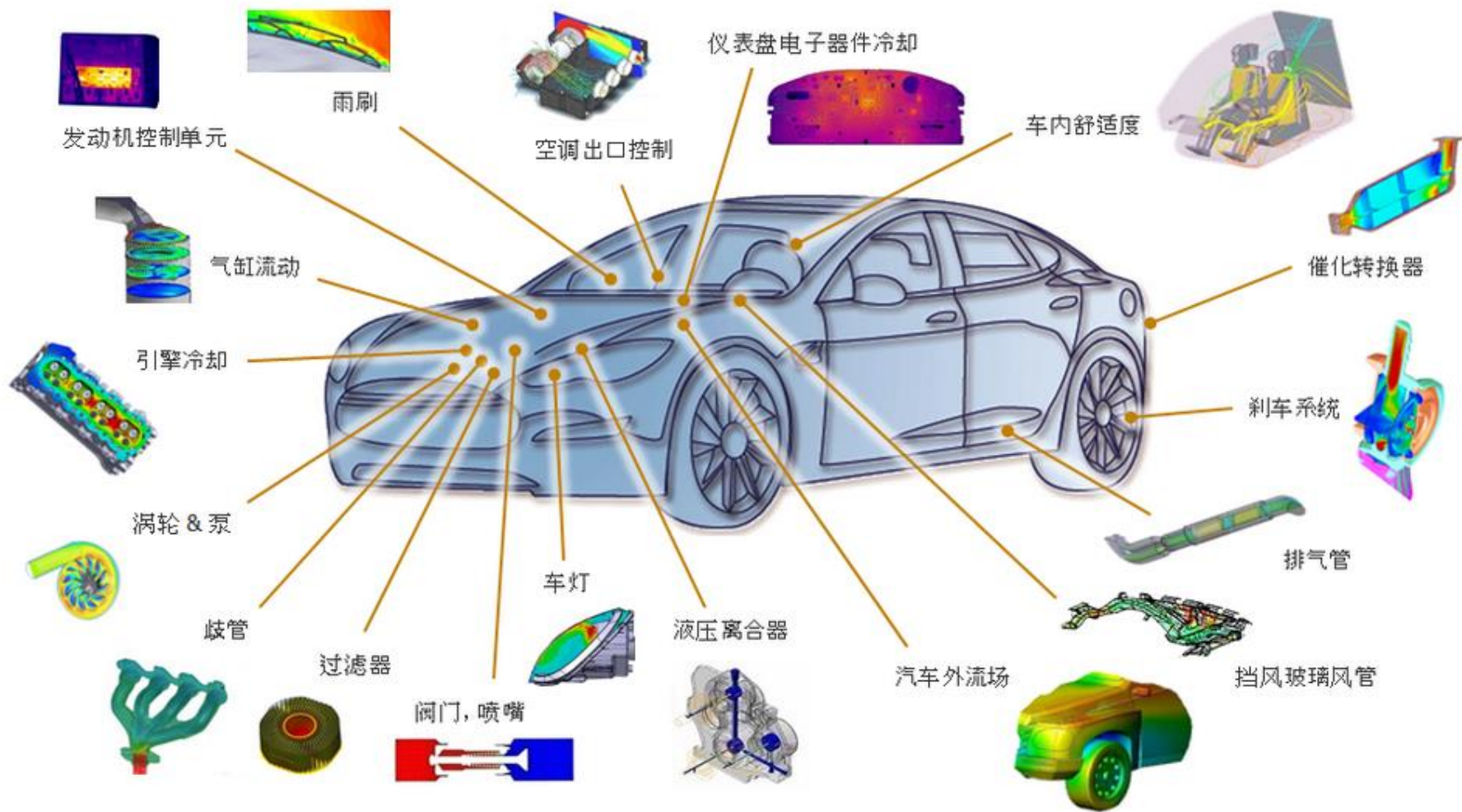

FloTHERM

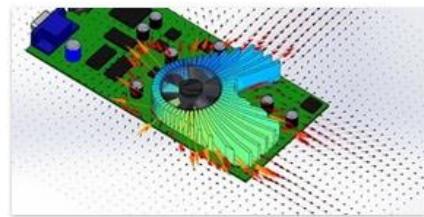

FloTHERM XT



FloEFD



FloMASTER

## 世界正在演变中...



从机械部件到集成机械，电子和控制的智能系统

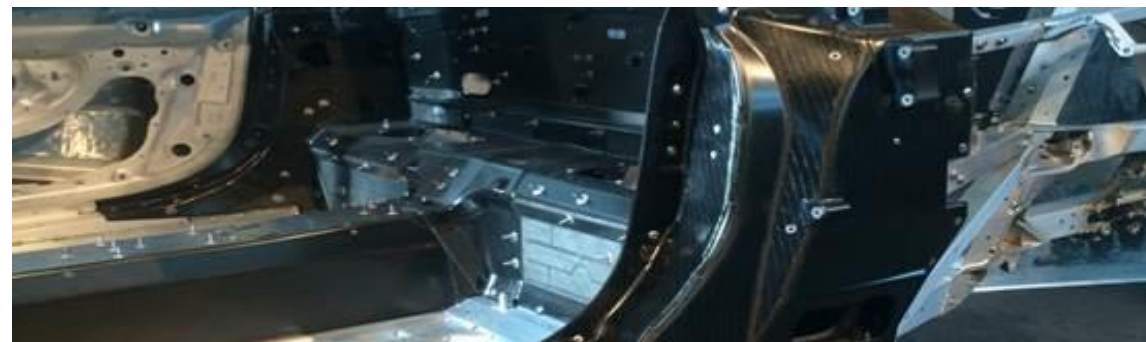

从已知的材料和制造方法到混合材料，创新的制造方法



从给定的选项到大面积的定制化和个性化

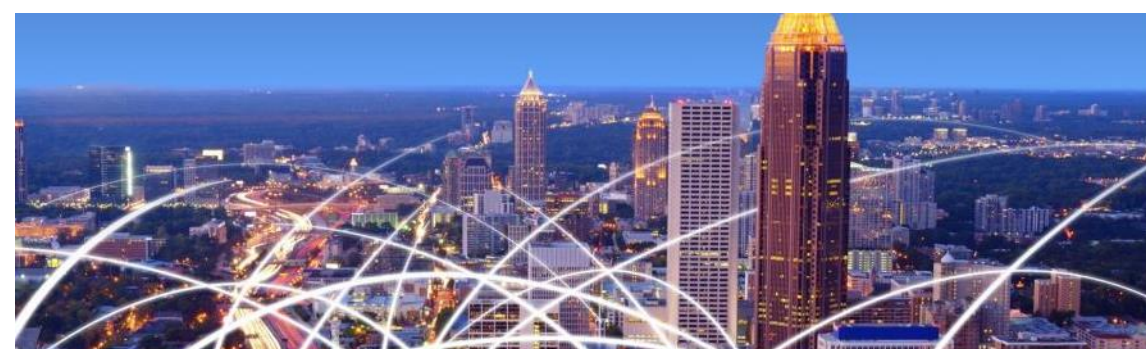

从互联网到系统组成的系统及物联网

一直不变的是：应对这些工程挑战...  
...而不影响时间、质量和成本

SIEMENS



## 提出Simcenter™，用于预测性工程分析

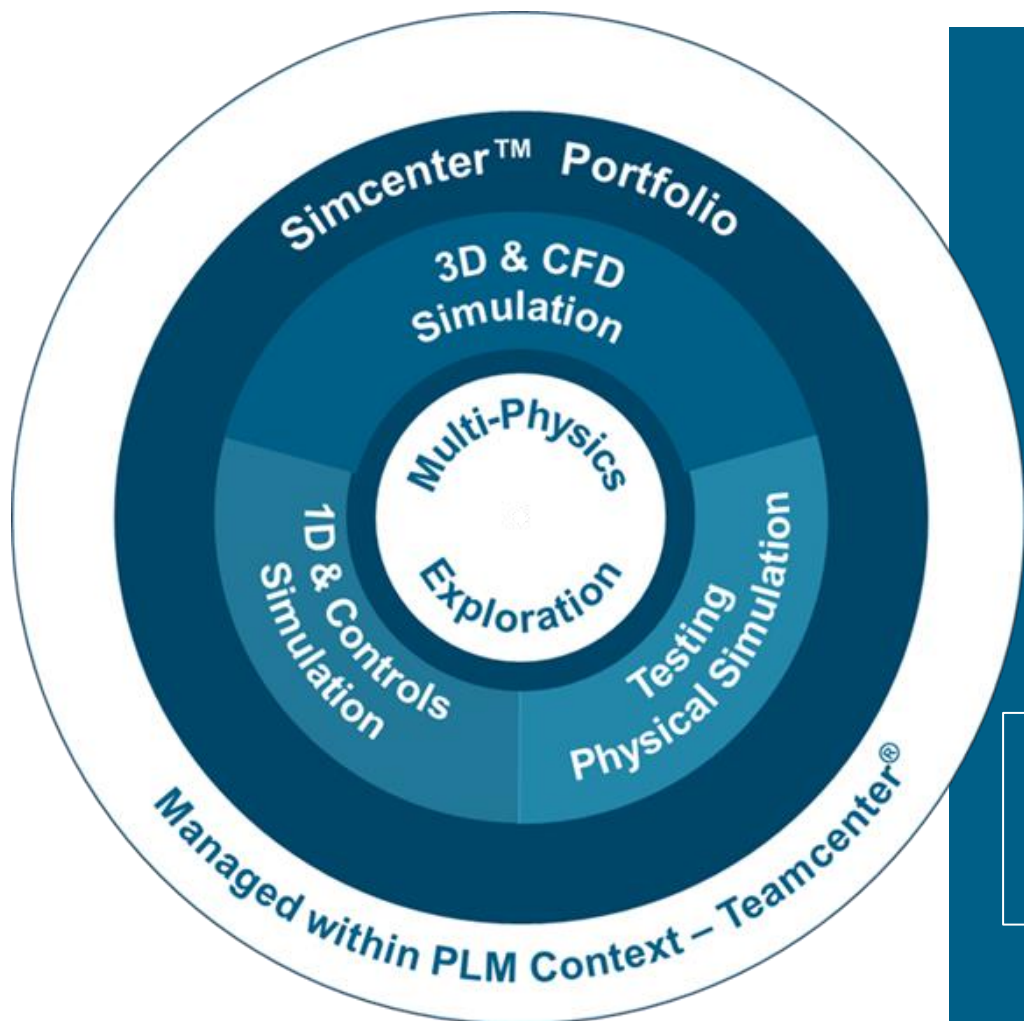

# 产品工程必须演变

## 提出Simcenter™ 用于预测性工程分析

西门子提出Simcenter, 用预测分析来推动性能工程转型

Press Release, June 14<sup>th</sup> 2016

# 产品工程的演化

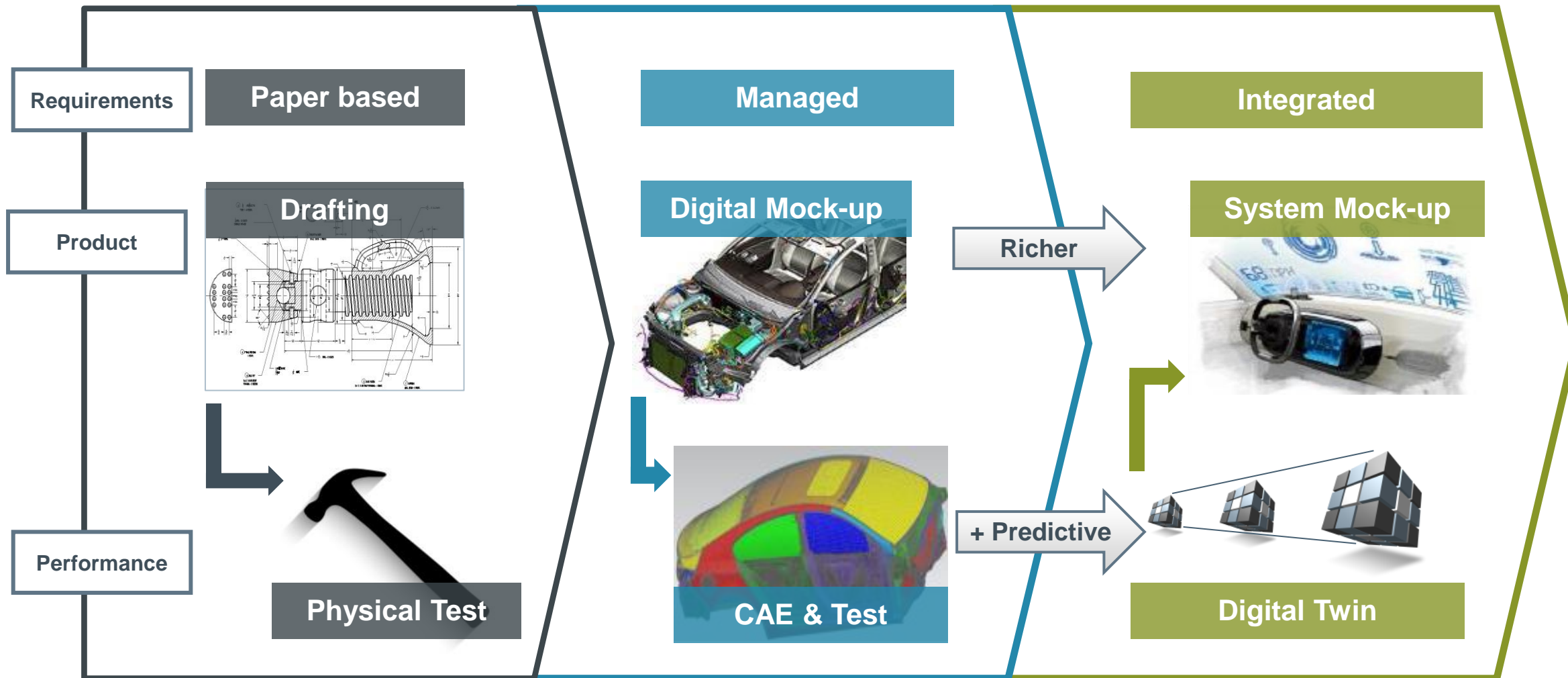



# 从离散的数据和模型 ...

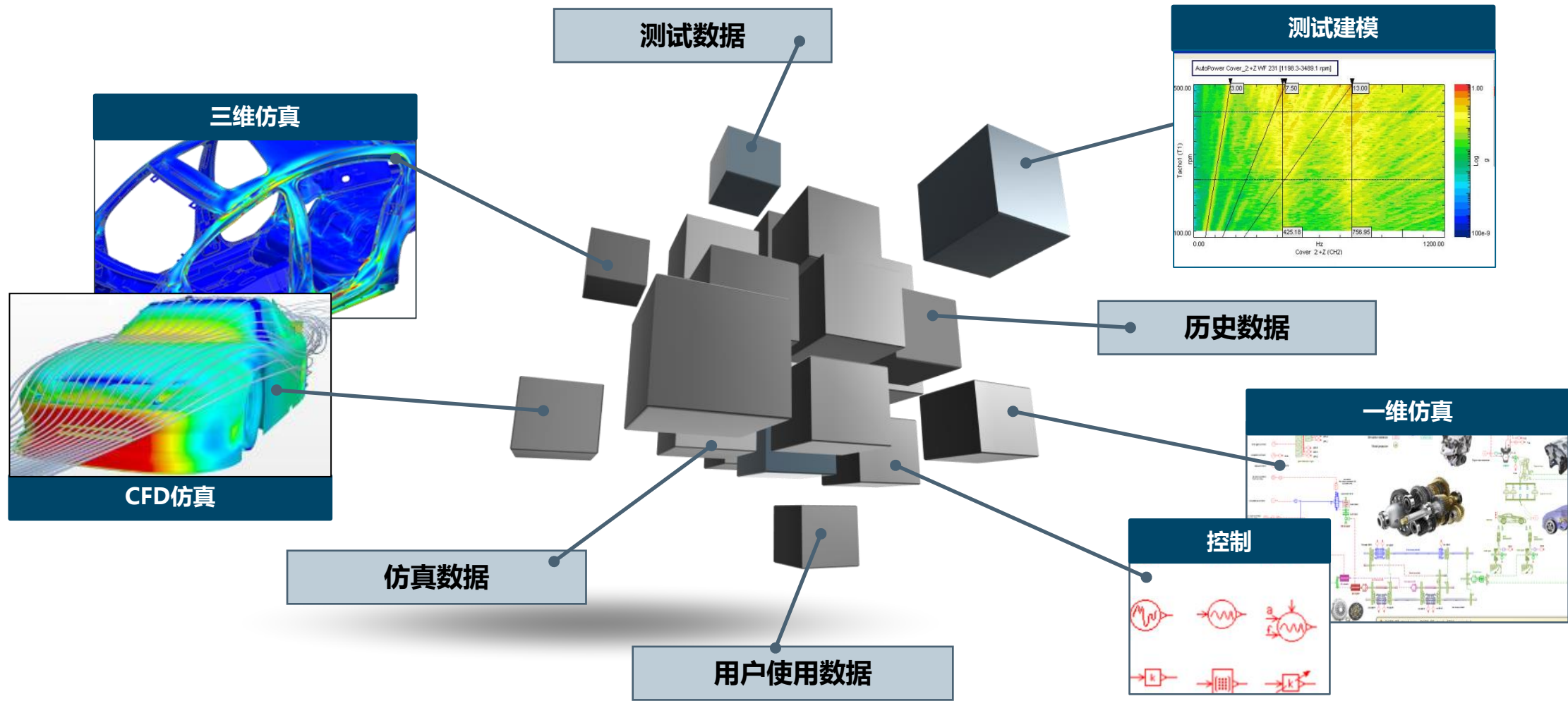

# ...到性能数字双胞胎

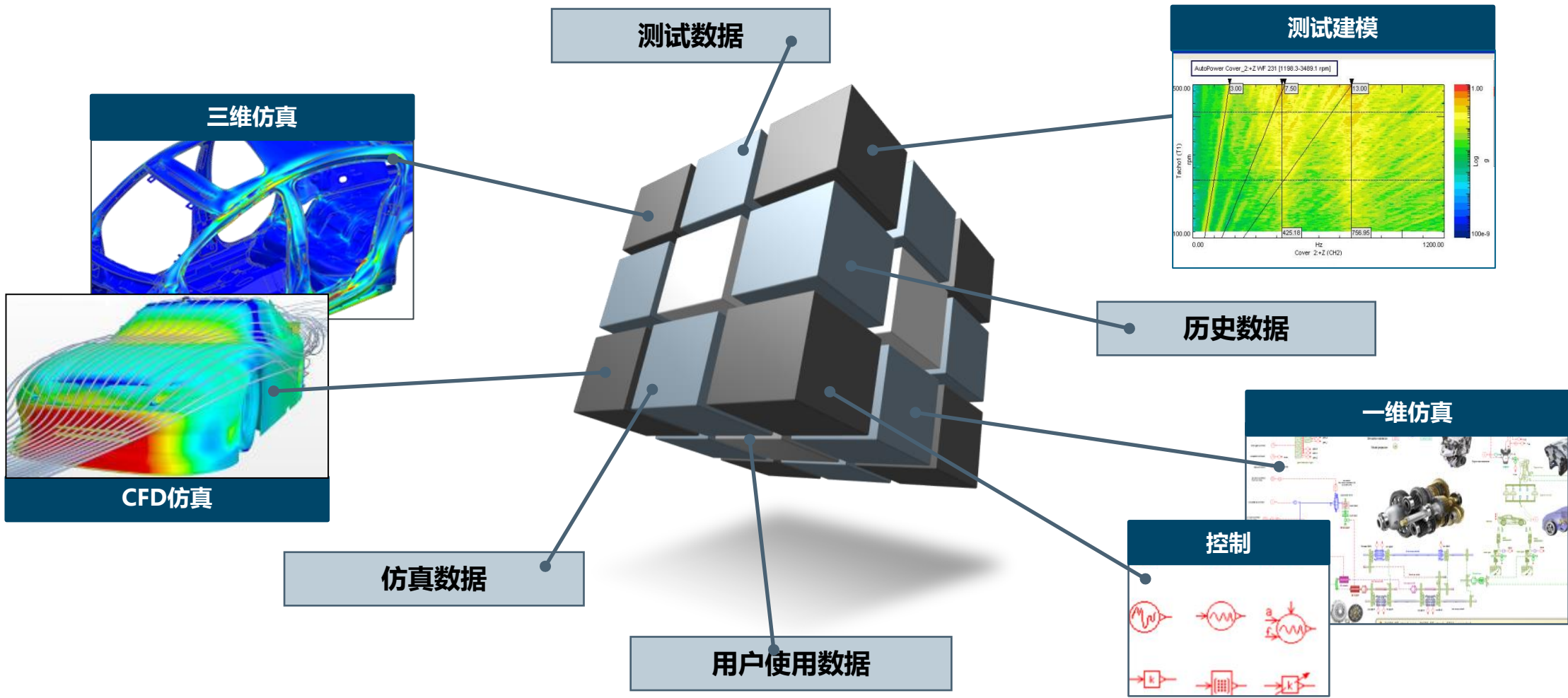

# ... 实现预测性工程分析

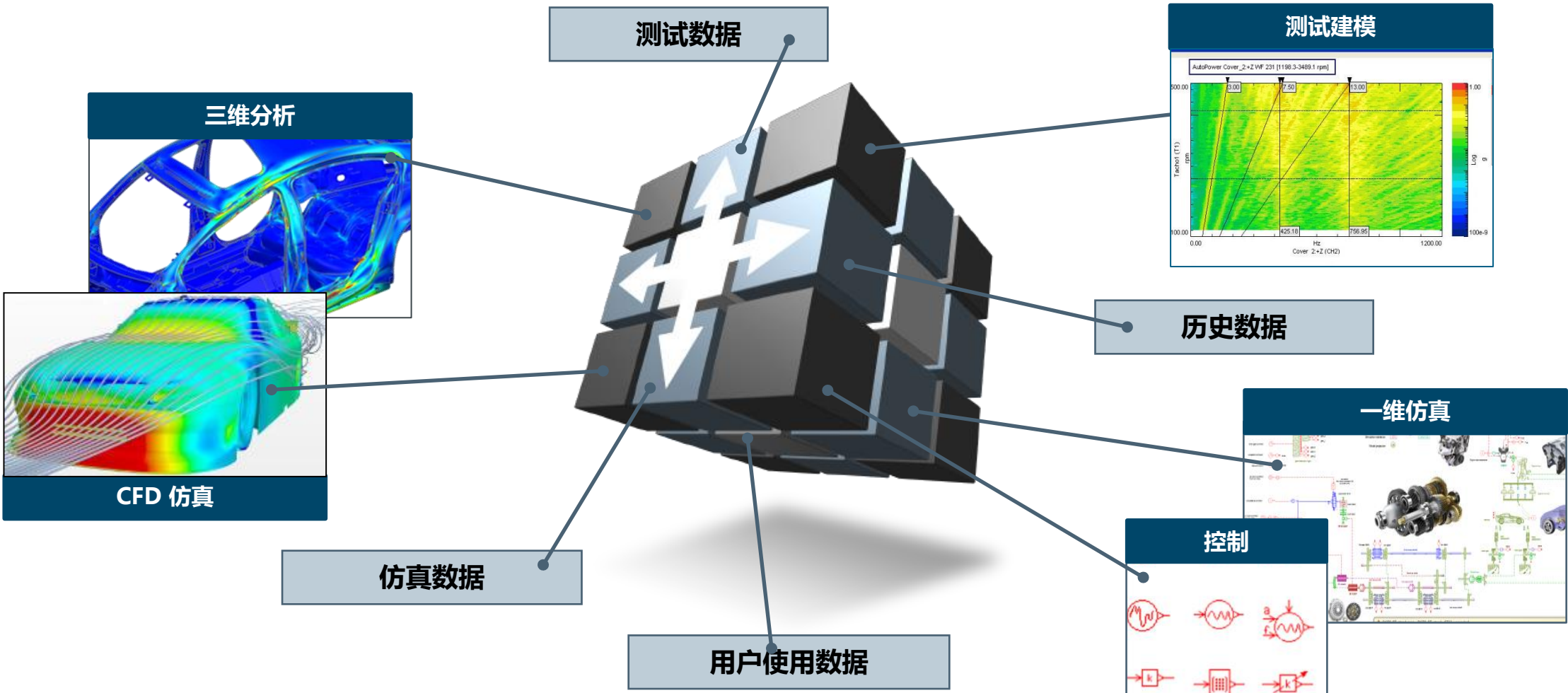

# 应对预测性工程分析的解决方案-- Simcenter™ Portfolio

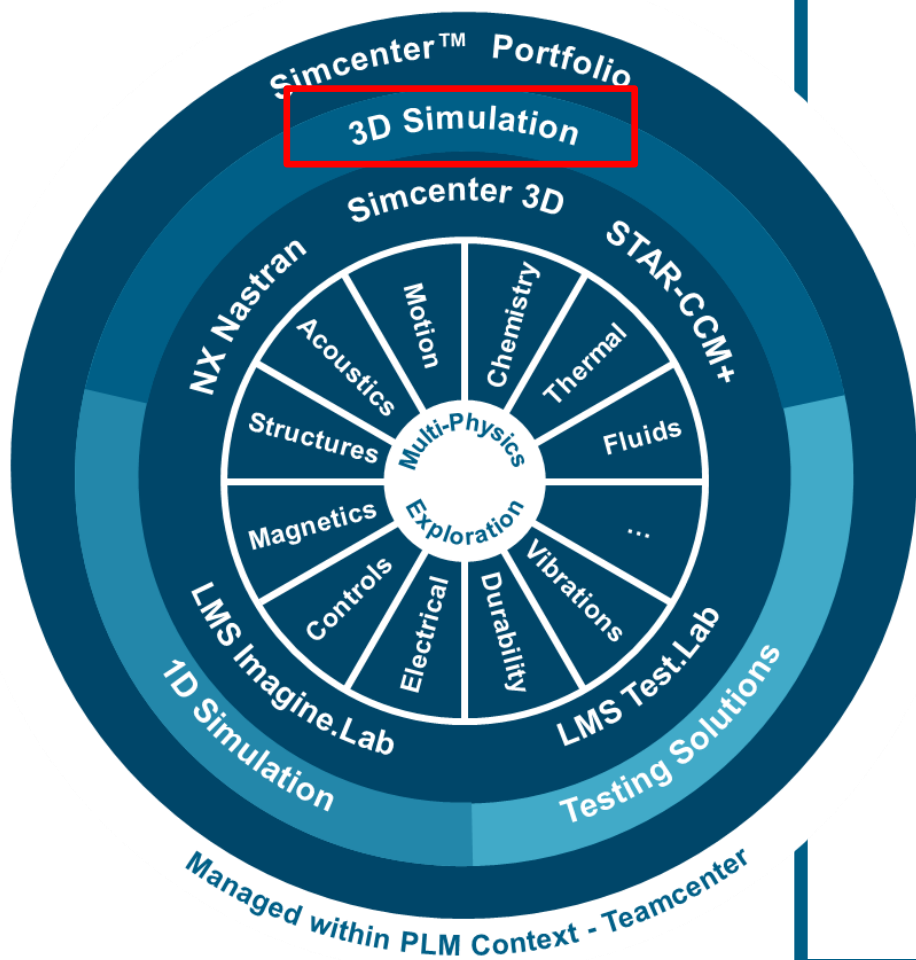

# Simcenter™

# Simcenter 3D仿真

→以NX为产品基础架构，连接设计、1D仿真、试验、数据管理

SIEMENS

# Simcenter™ 3D

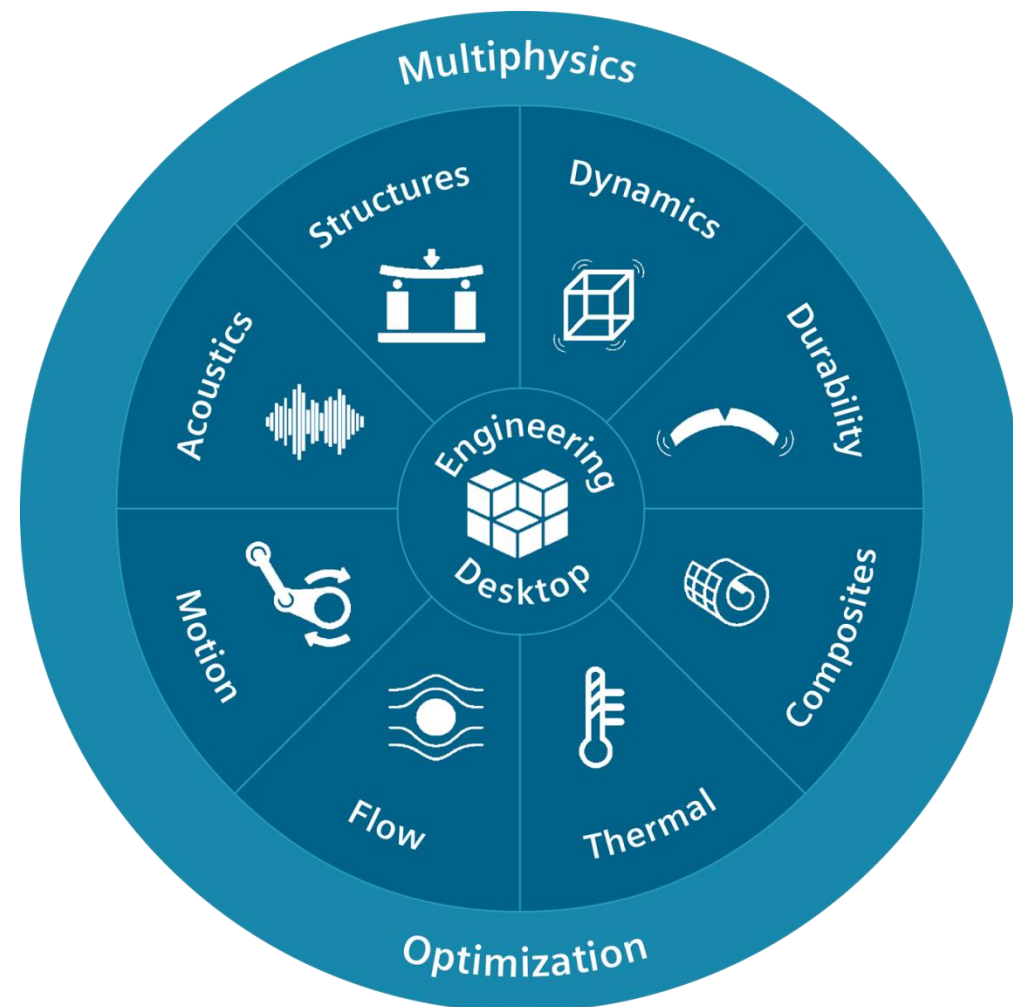

# Simcenter™ 工具组合推动预测工程分析流程

## Simcenter™ 3D & NX Nastran

SIEMENS

测试-仿真  
相关性

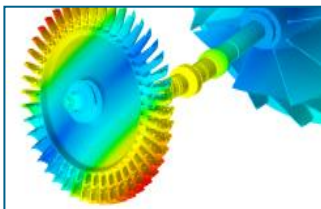
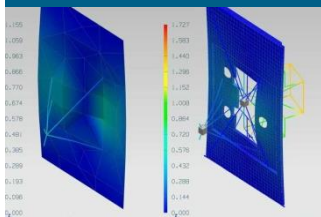

3D 前后处理  
结构仿真  
声学模拟  
机构运动  
复合材料

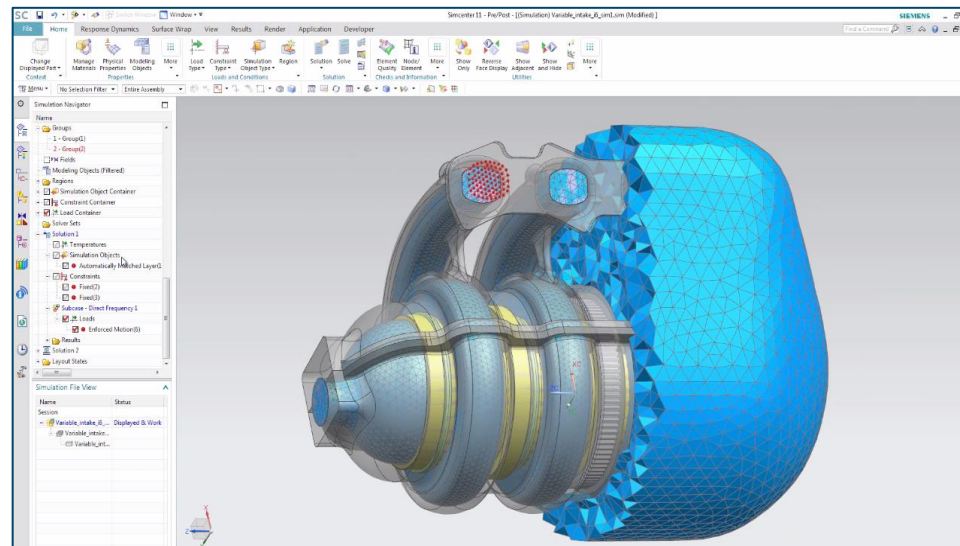

NVH  
结构动力学  
疲劳耐久  
热流  
优化

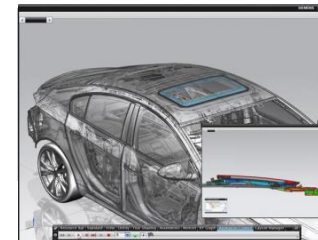

1D - 3D  
耦合分析

多物理场

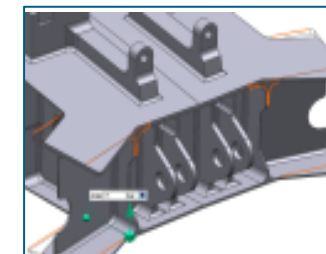
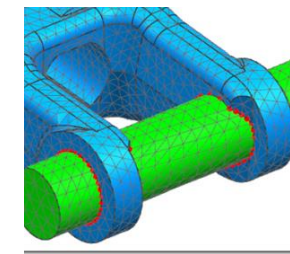
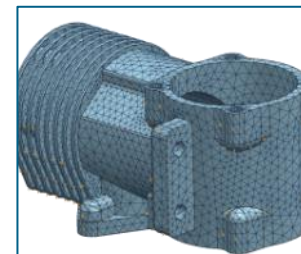
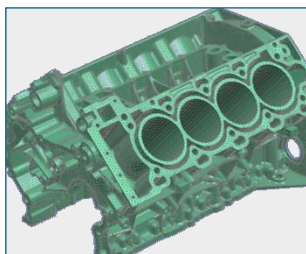
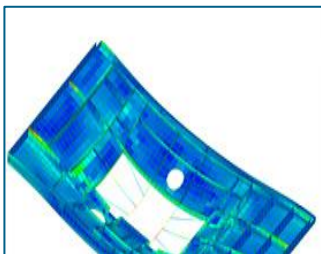

线性有限元

非线性有限元

边界元技术

多体动力学

疲劳仿真

热分析

计算流体动力学

仿真数据管理平台

最佳的仿真建模工具

多学科仿真集成

开放性和可扩展性

领先的系统仿真

行业专家知识

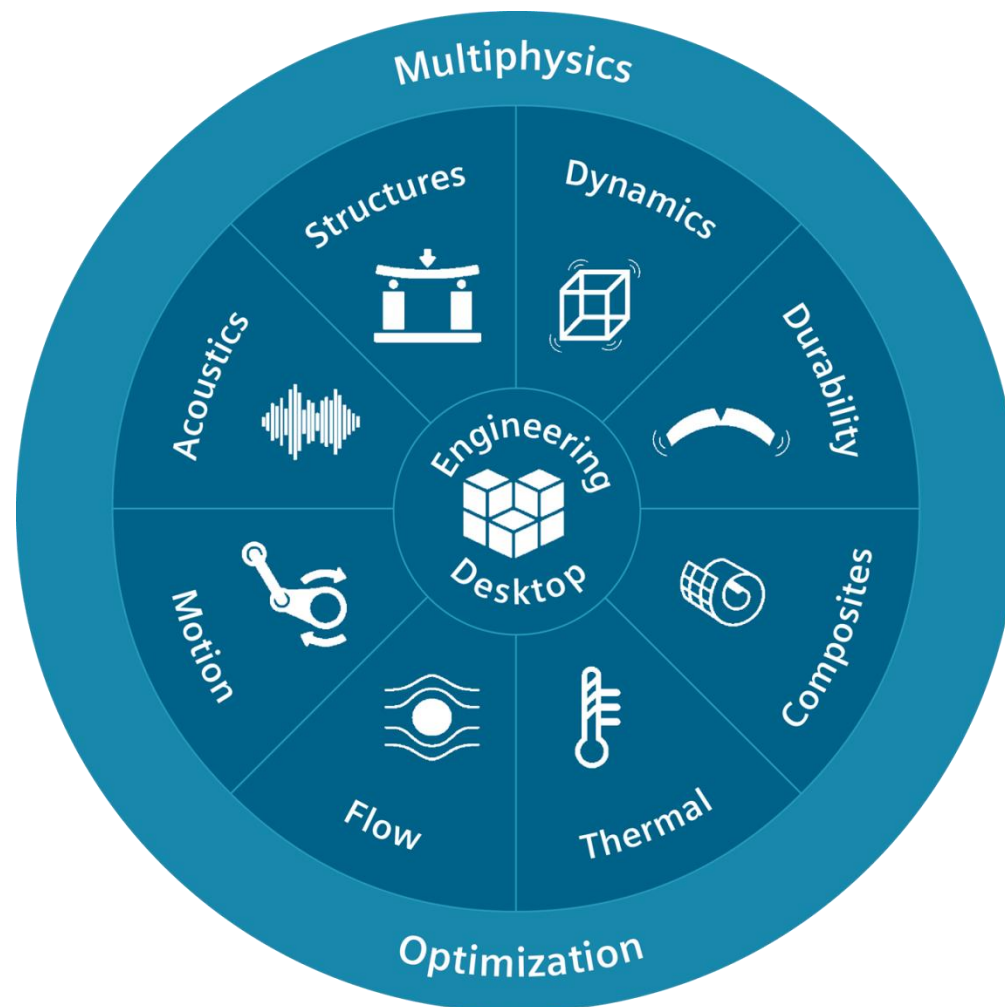

### 最佳的仿真建模工具

多学科仿真集成

开放性和可扩展性

领先的系统仿真

行业专家知识

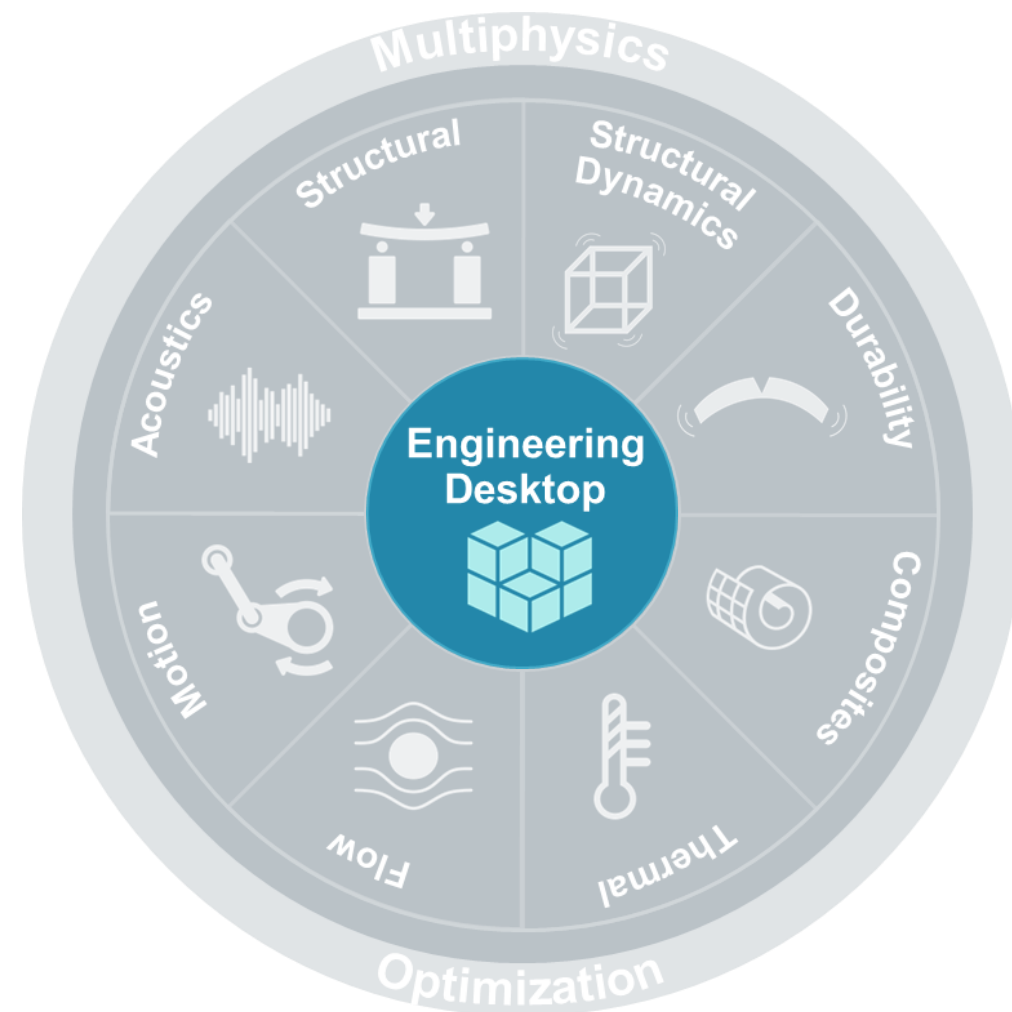



# Simcenter™ 3D vs. 传统仿真工具

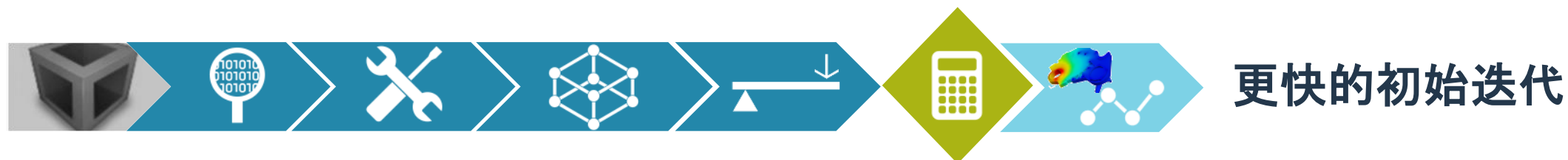

# Simcenter 3D

# Simcenter™ 3D 独一无二的现代仿真平台 嵌入CAD 功能

SIEMENS

- 实体 & 特征建模– 直接建模技术(同步建模)
- 装配建模
- 自由建模, 基本和高级
- 动态的、逼真的渲染模型技术

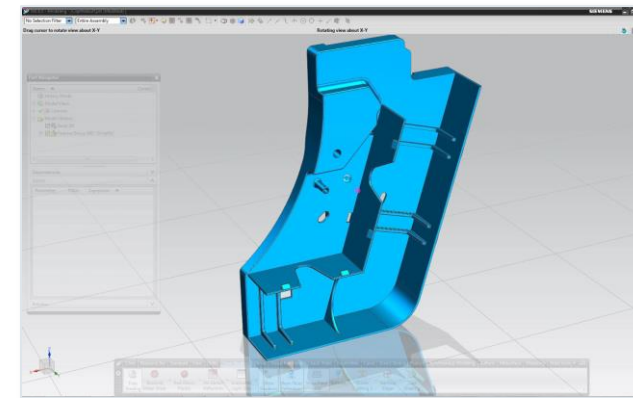

减少为网格划分而简化模型的时间



快速更新分析模型反映设计几何的变更



# Simcenter™ 3D 独一无二的现代仿真平台 完善的网格处理工具

SIEMENS

- 稳健的自动/手动网格划分工具，包括1D, 2D 和3D 网格
- 关联几何模型/ 能够关联读入的孤立网格模型
- 利用网格变形技术，激活过去的网格模型
- 利用装配有限元技术，自动映射相同的部件网格模型

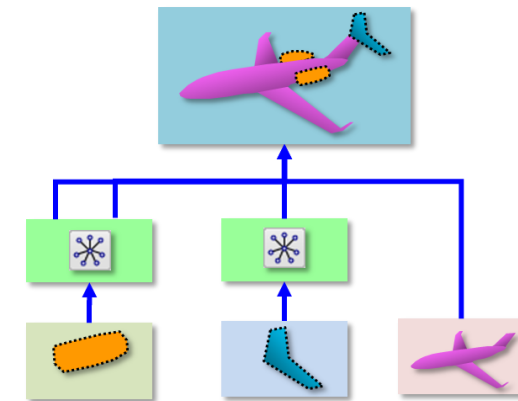
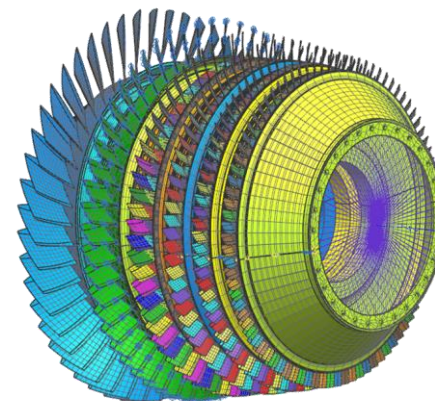

## 划分最具挑战性的模型网格



## 快速创建, 连接和管理各种不同的网格模型



# 大众汽车部署“数字双胞胎”

Simcenter 11快速的建模和迭代过程，真正实现仿真驱动设计

SIEMENS



## 创建汽车“数字双胞胎”

最小化建模时间

自动实现从CAD到CAE模型

加速设计提升过程

提高模型质量和可靠性

## 加速的仿真模型创建和模型更新，帮助减少新车上市周期

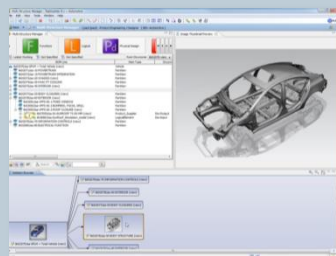

数据管理+  
关联几何模型

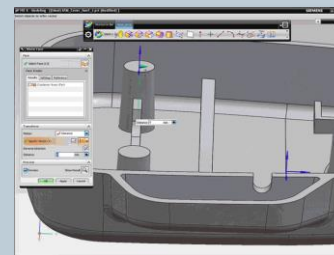

同步建模实现仿真和设计模型实时同步

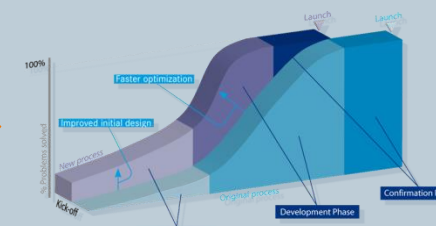

加速产品上市

**“3小时的时间内，我们针对4种不同的设计方案进行仿真评估，并且当天下午，我们设计的方案就被去加工了”**

Andre Van der Watt, Chief Technology Officer, VW Group South Africa – Motor Division

最佳的仿真建模工具

多学科仿真集成

开放性和可扩展性

领先的系统仿真

行业专家知识

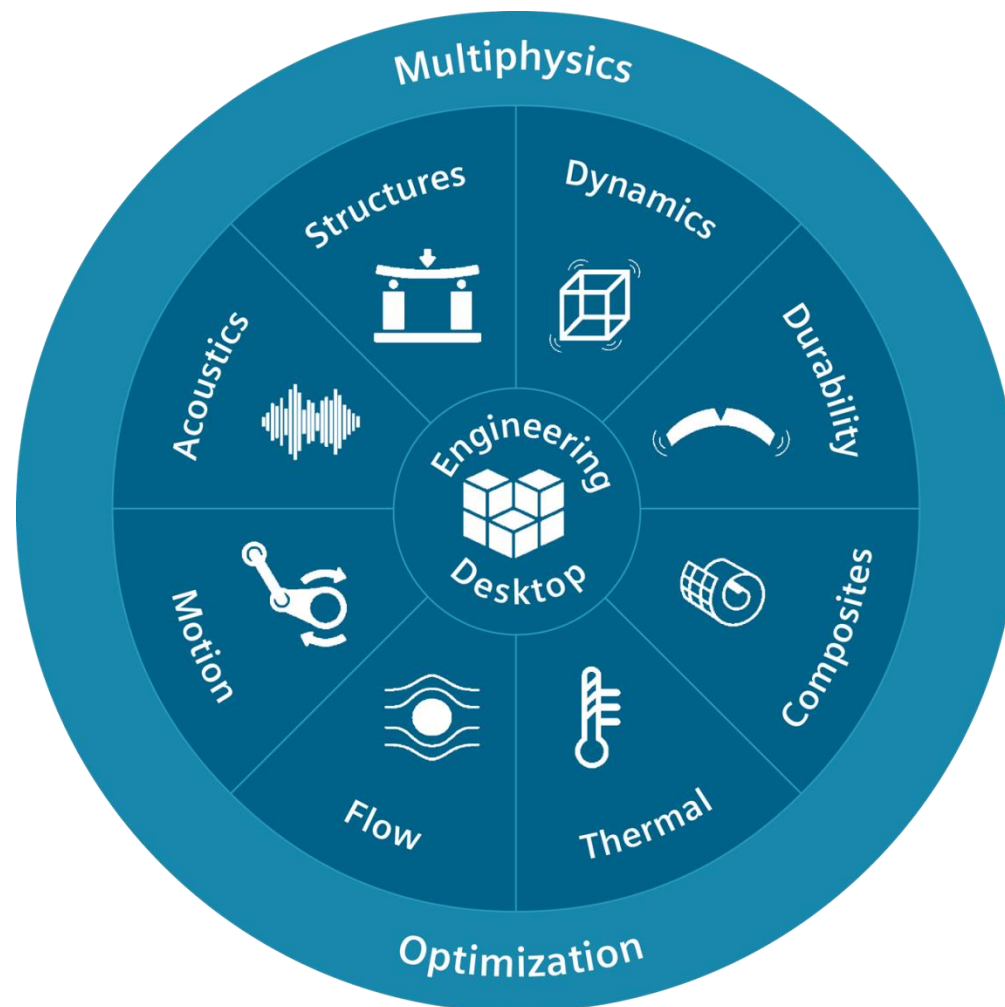

# 结构仿真

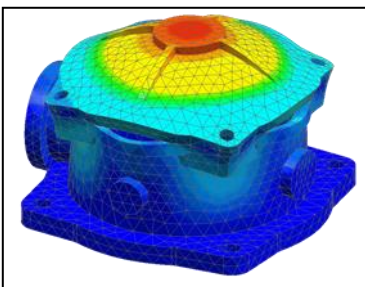

LMS Samcef

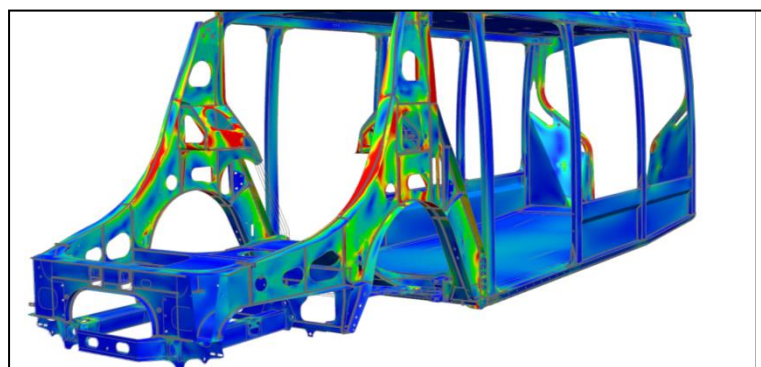
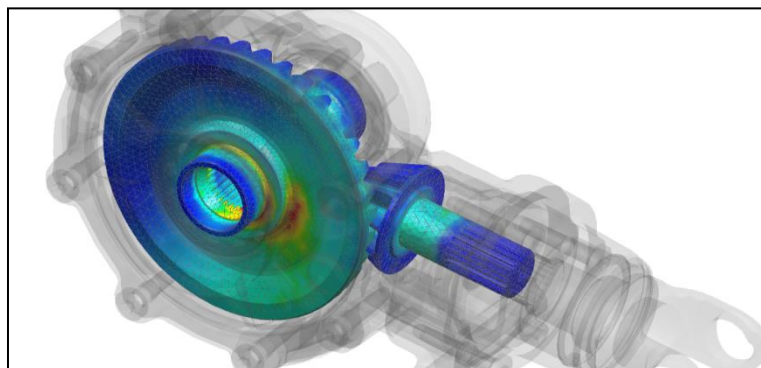
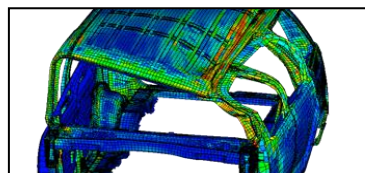

线性  
非线性  
模态  
屈曲分析

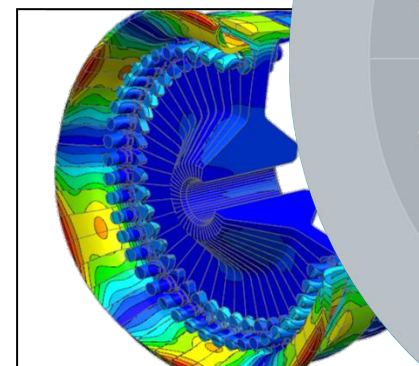
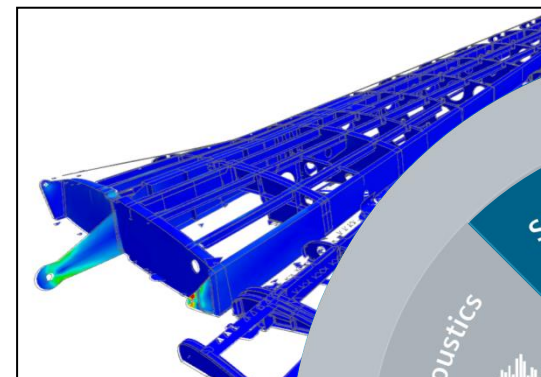

NX Nastran

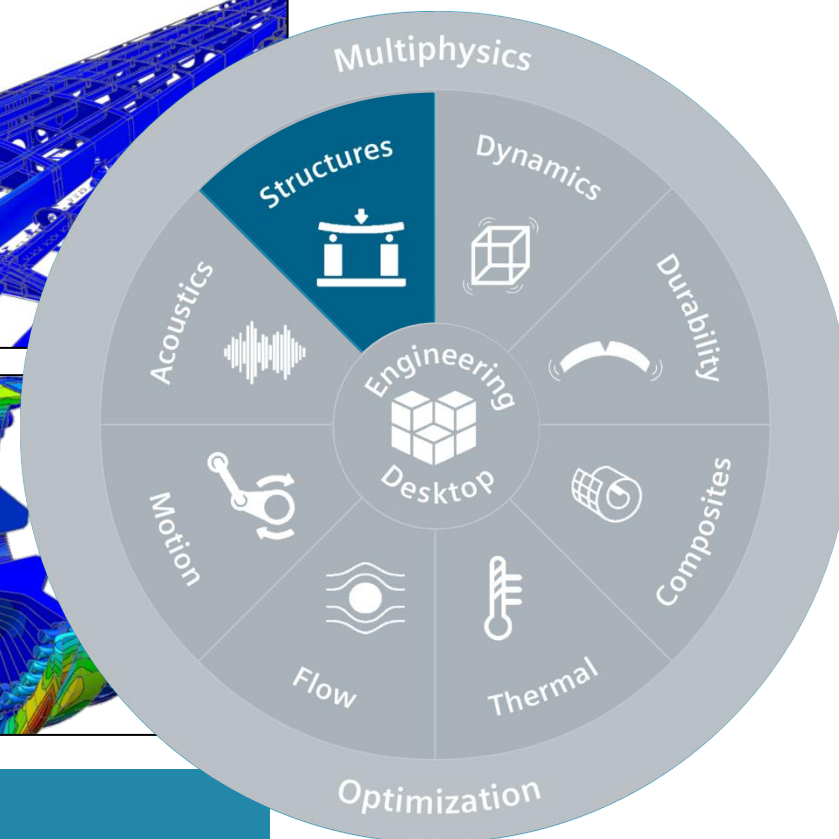

# 动力学

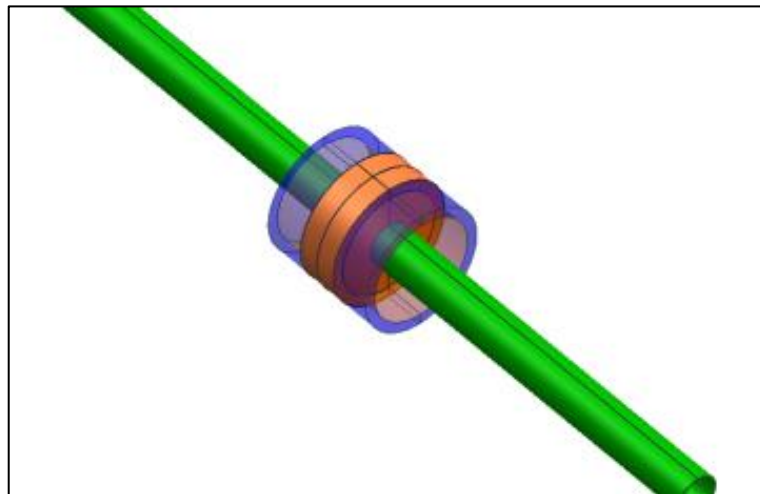

瞬态分析  
 频响分析  
 随机振动  
 冲击响应  
 转子动力学  
 气弹分析

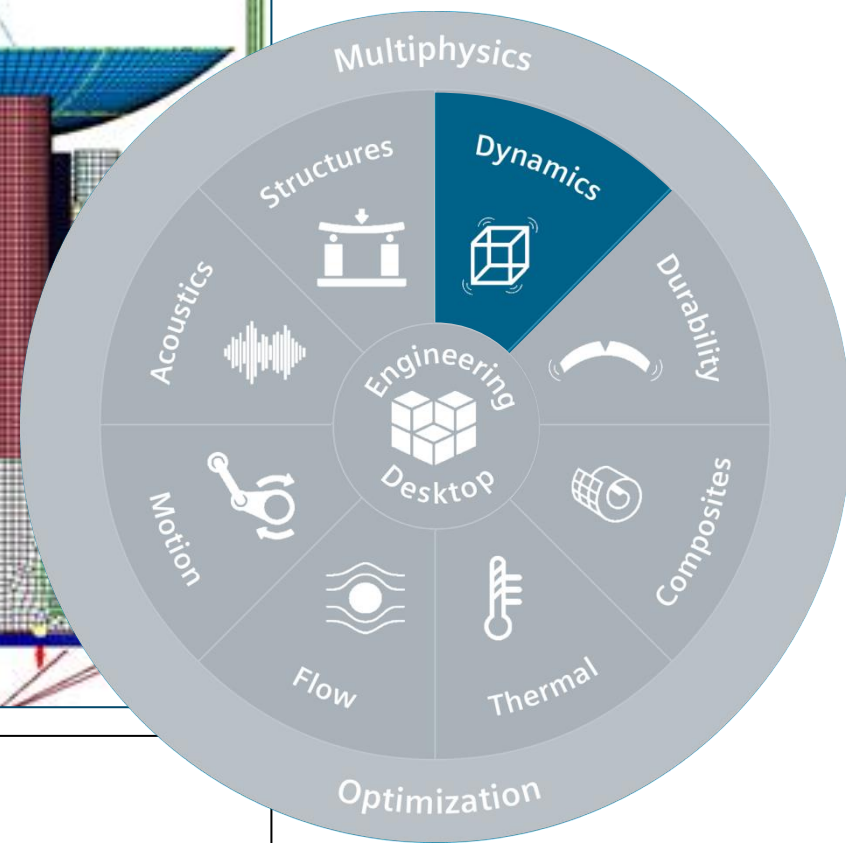
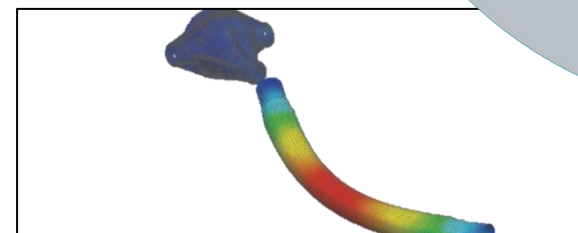
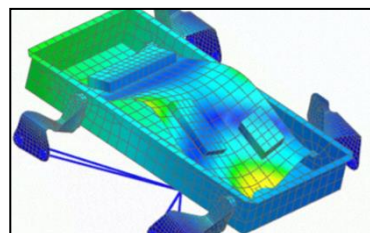
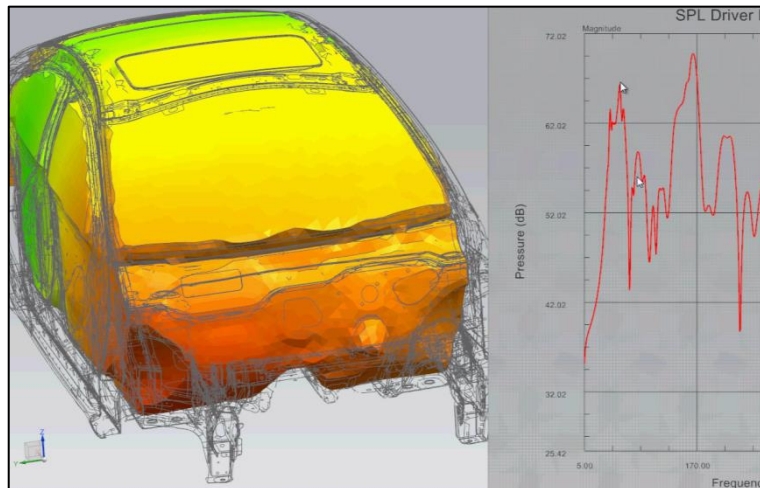
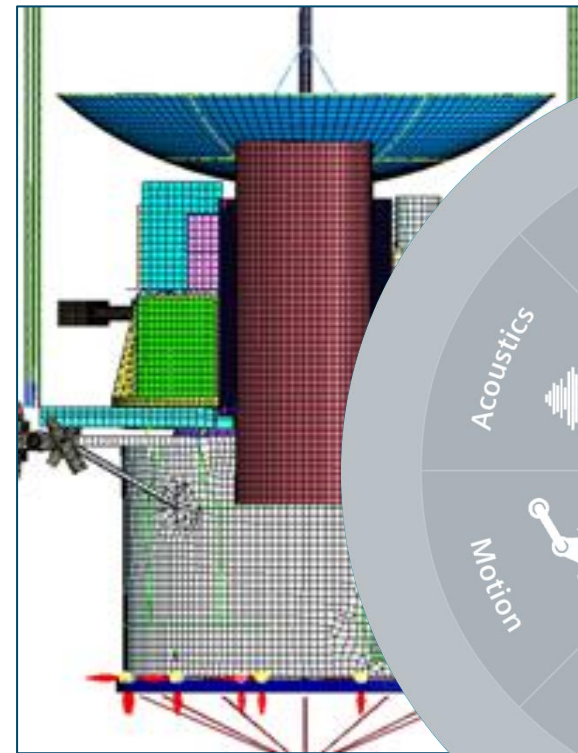

# 疲劳

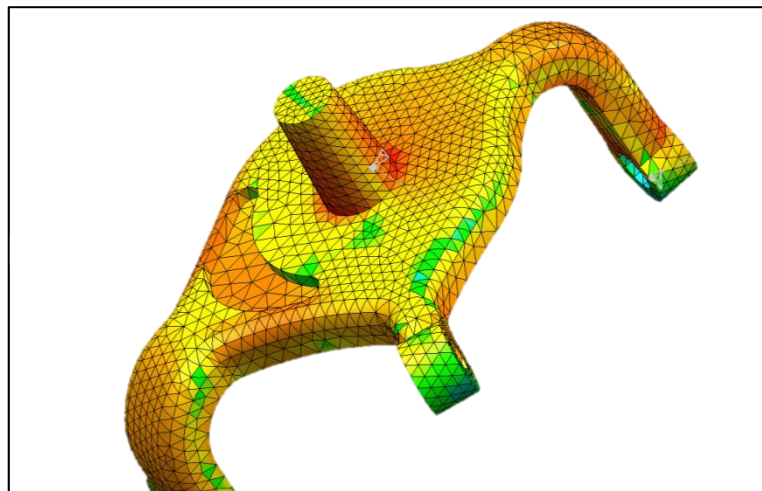

静态  
瞬态  
随机  
焊缝、焊点

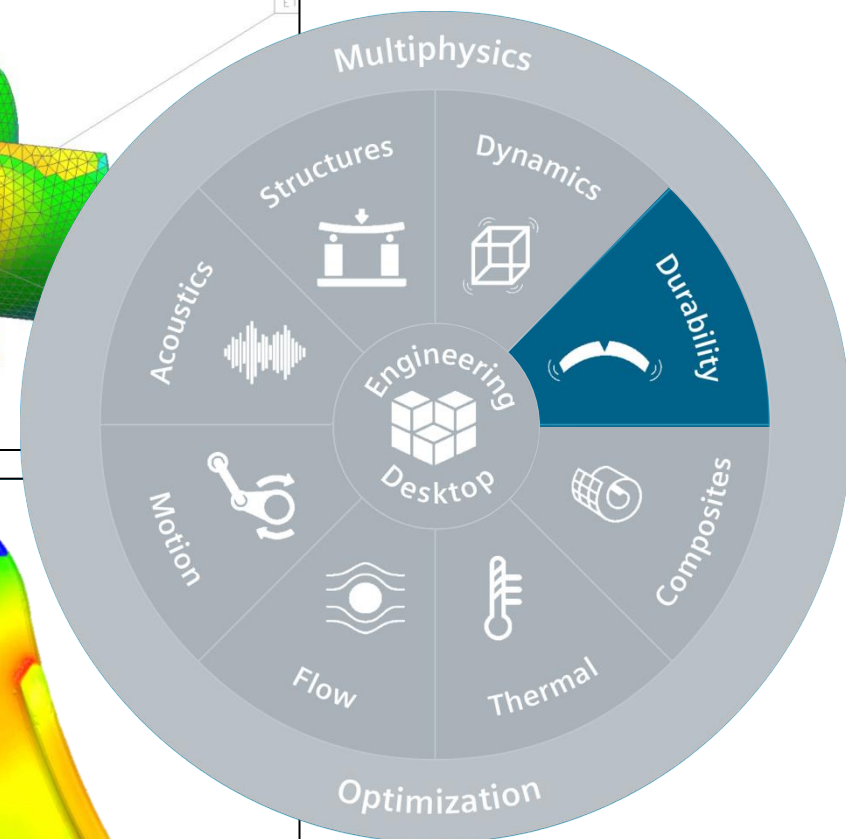
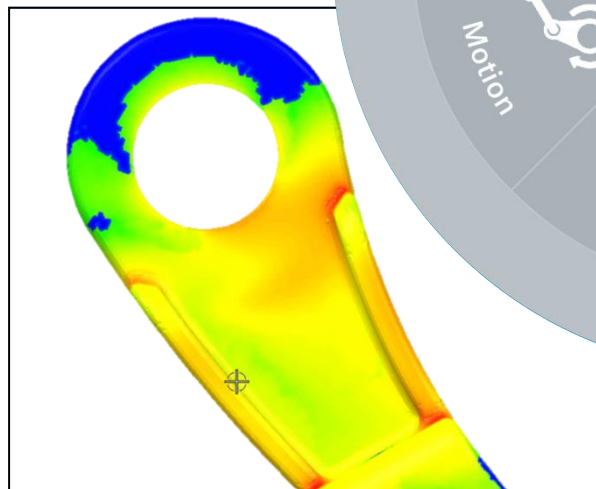
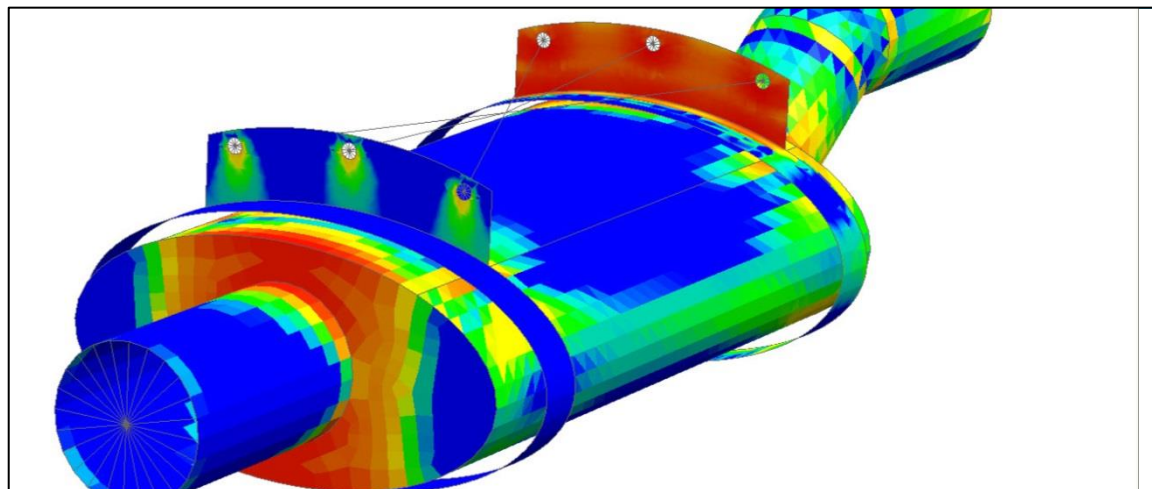
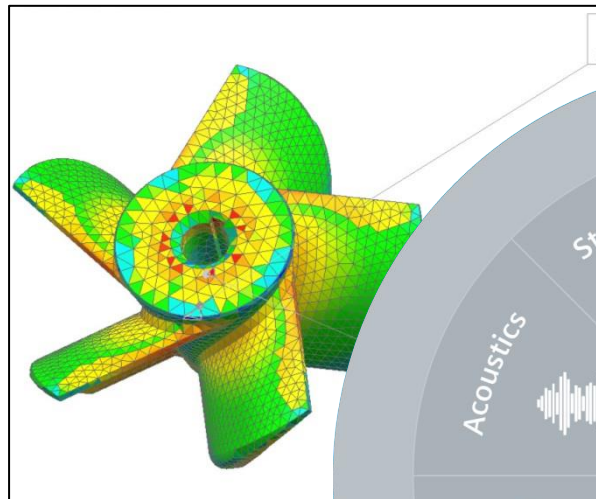



# 复合材料分析 行业最完整的仿真分析流程

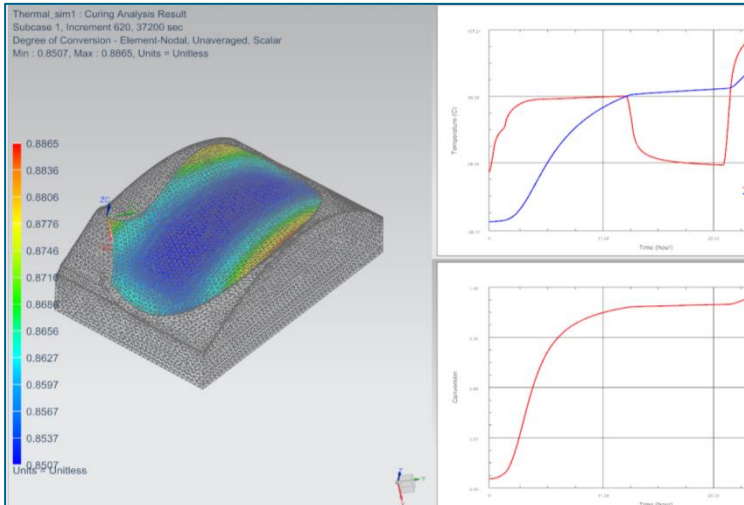
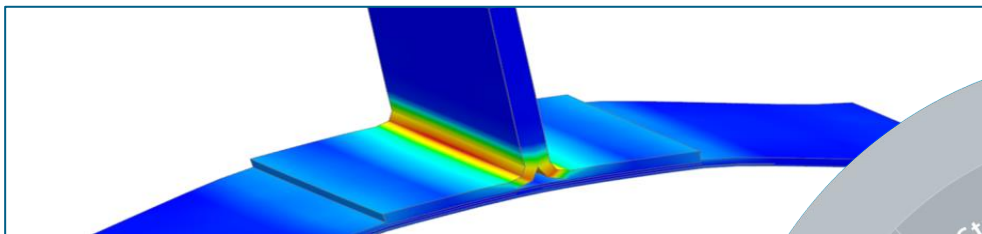
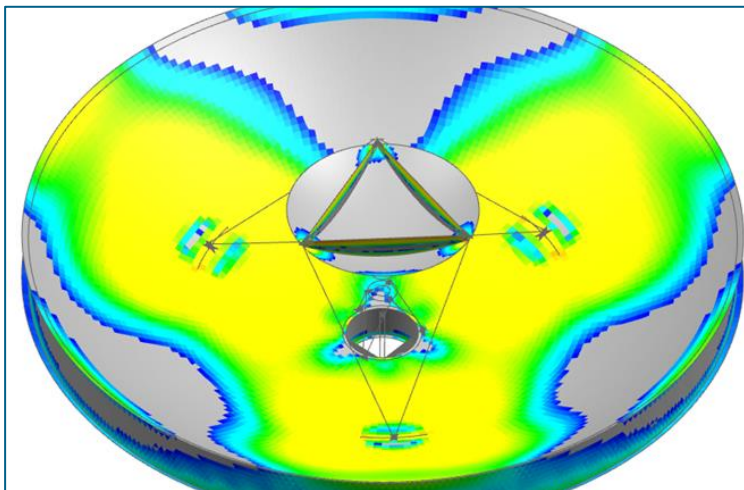

复合材料建模  
线性/非线性计算  
响应分析  
疲劳耐久  
损伤扩展  
加工过程模拟  
(固化和结晶)

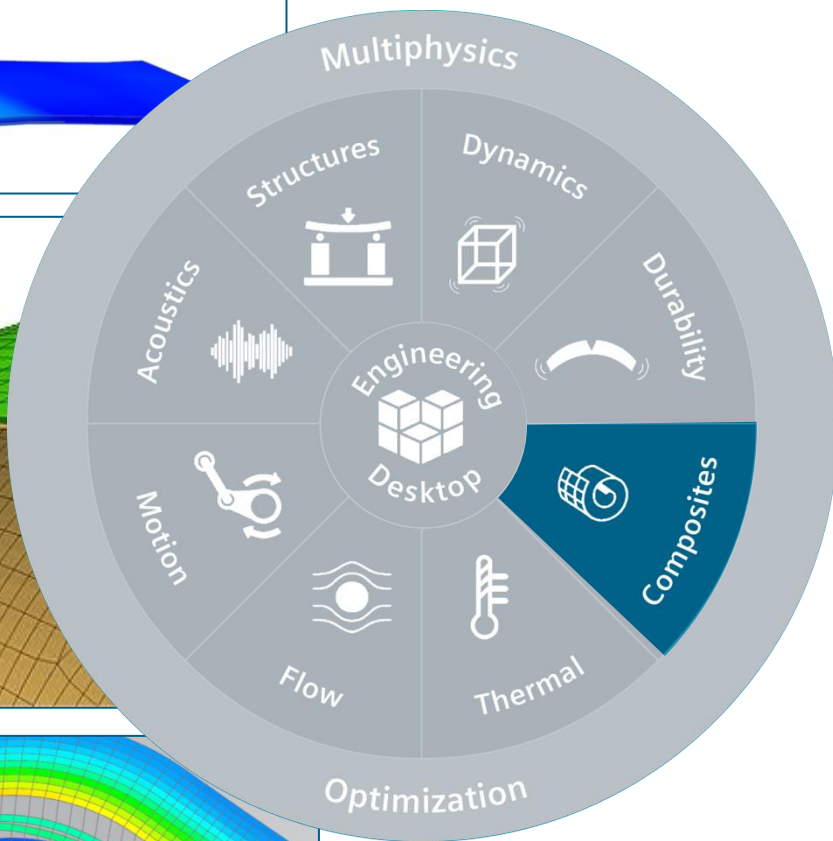
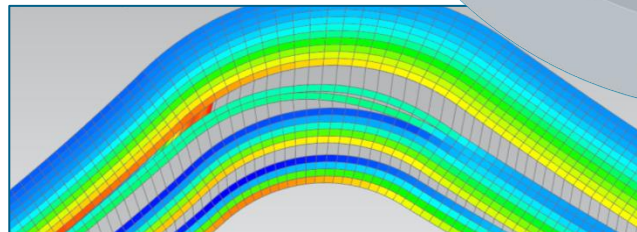
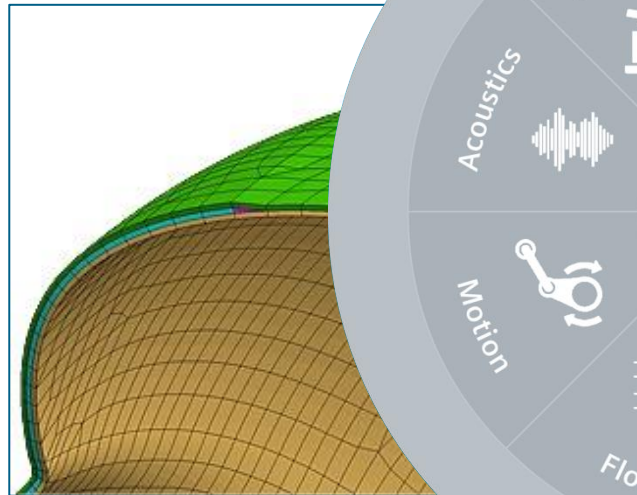

# 热仿真

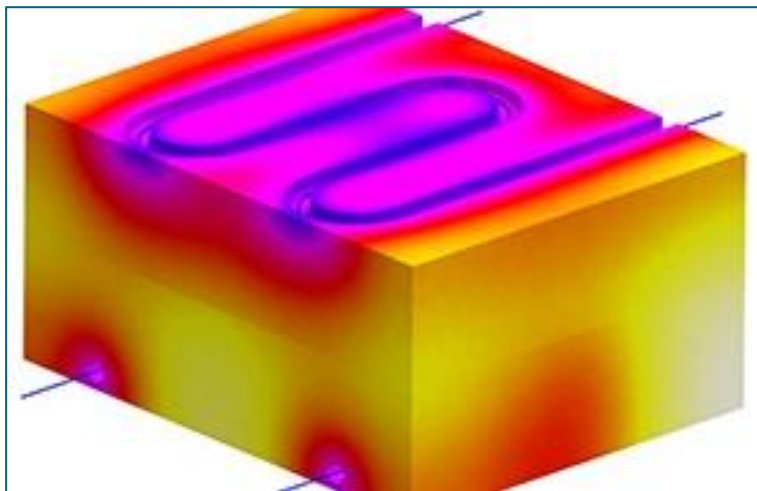

传导  
 对流  
 共轭热传递  
 辐射

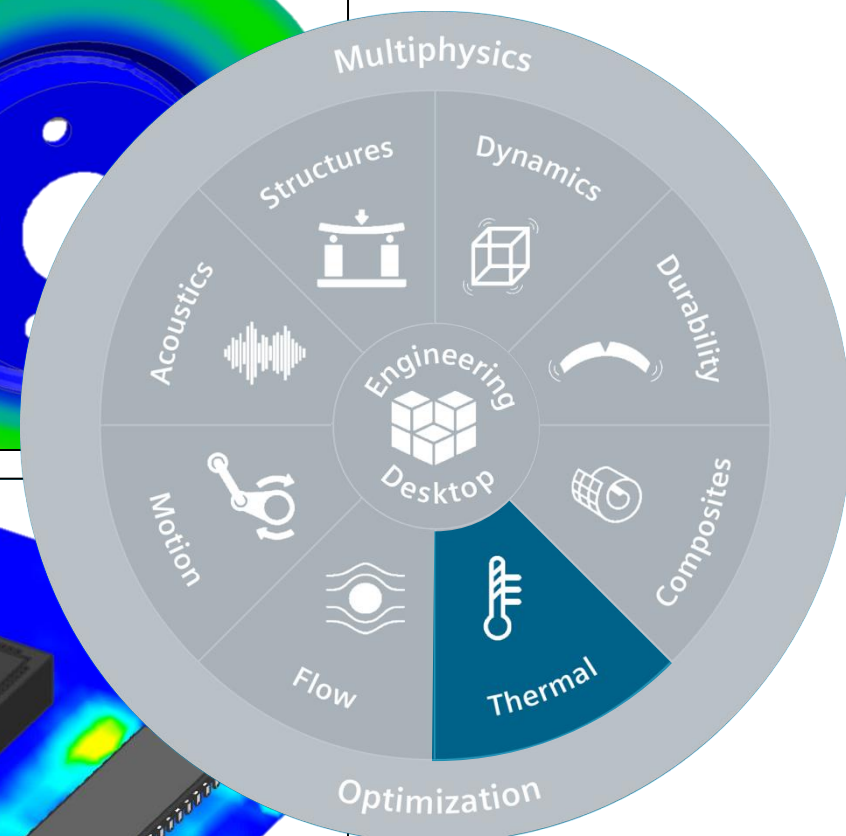
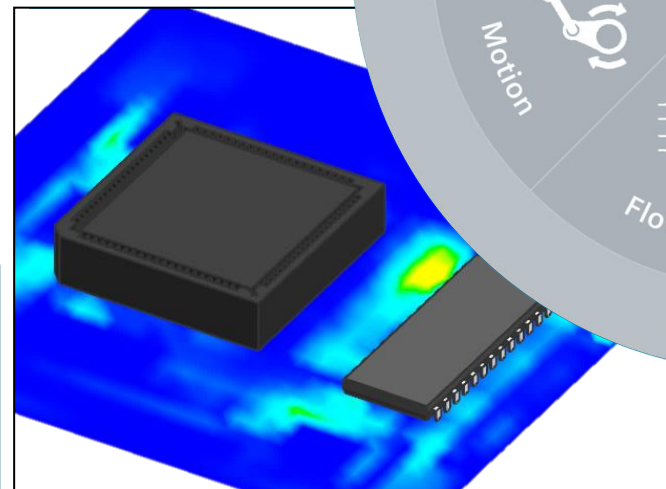
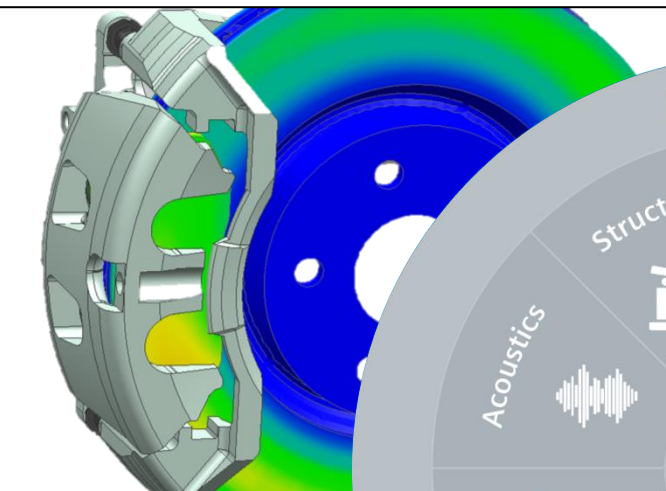
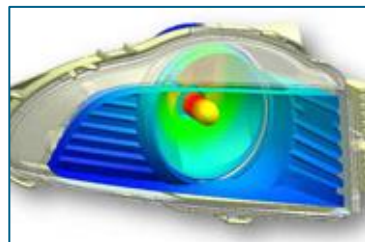
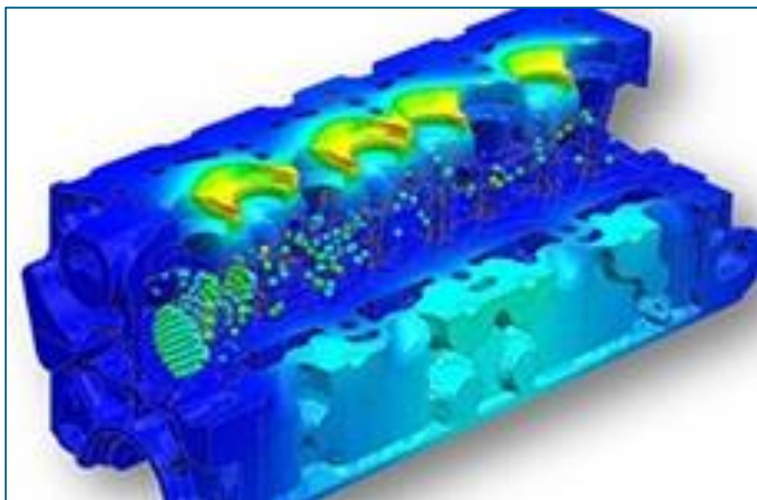

# 流体仿真

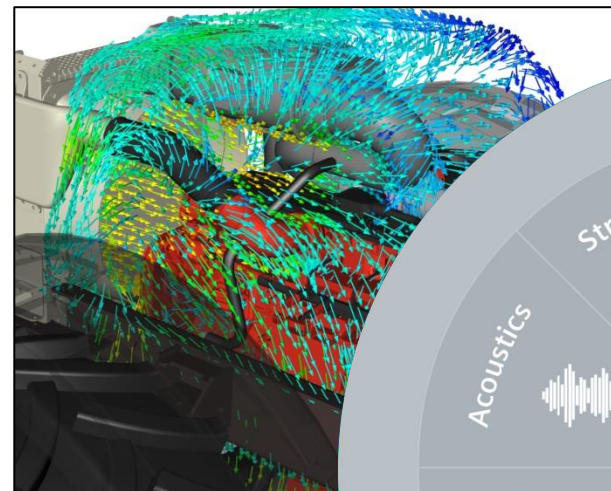
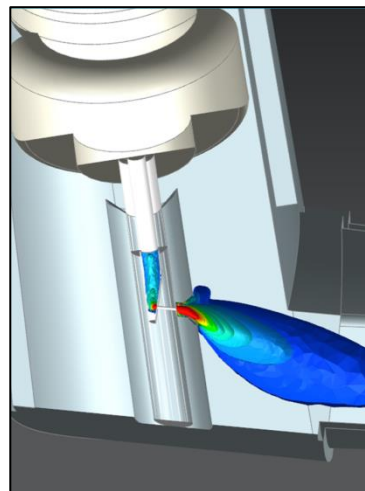
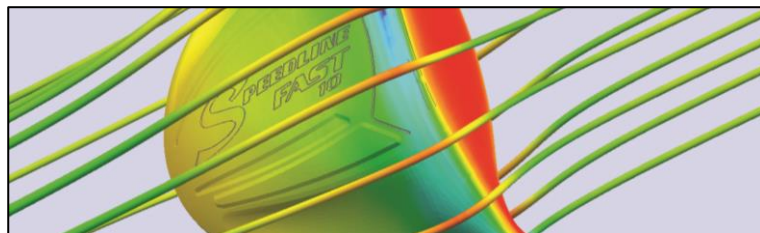

可压缩流

不可压缩流

非牛顿流体

两相流

1D 流体网络

流体网格

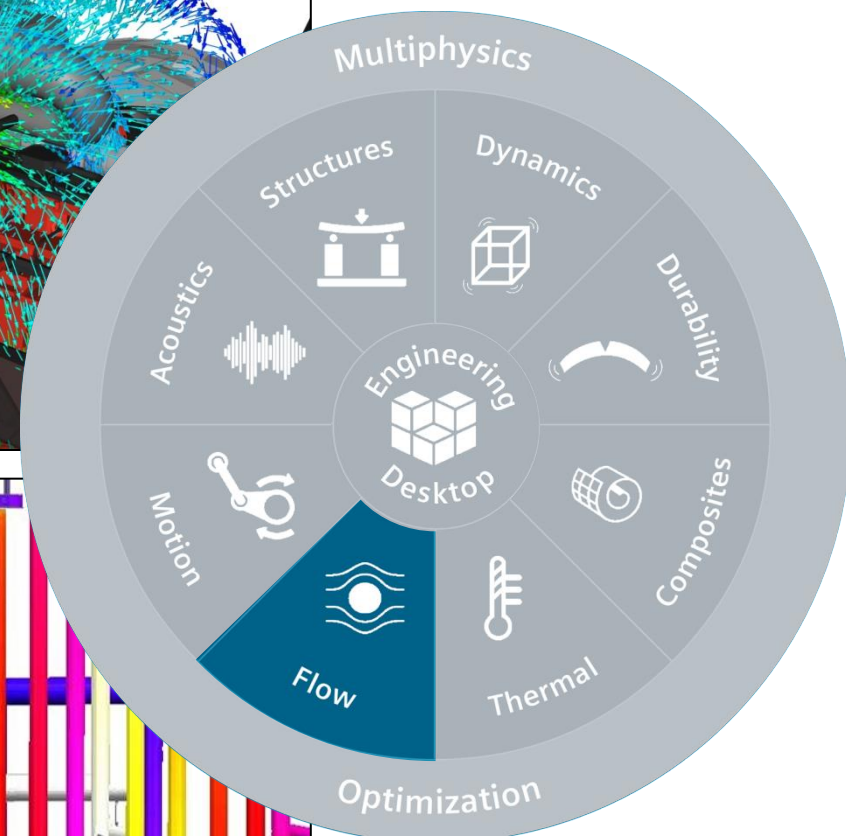
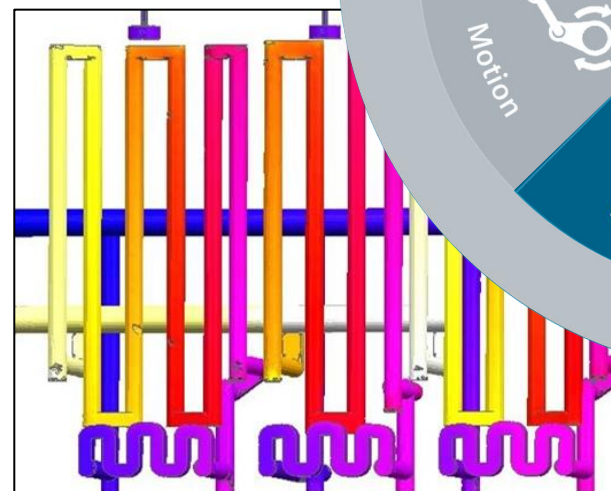
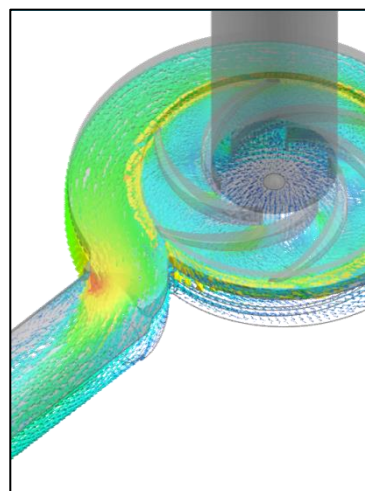

# 运动学分析

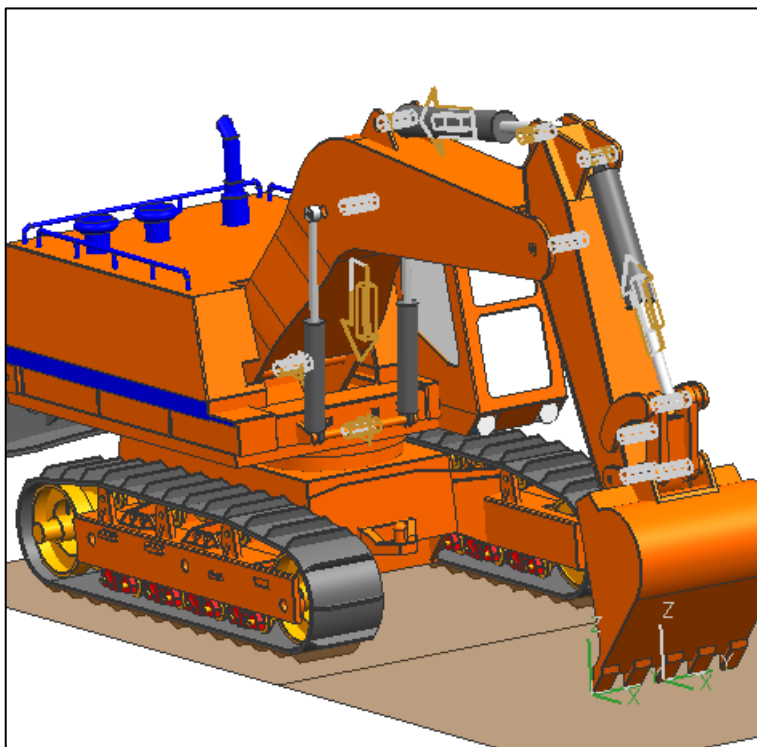
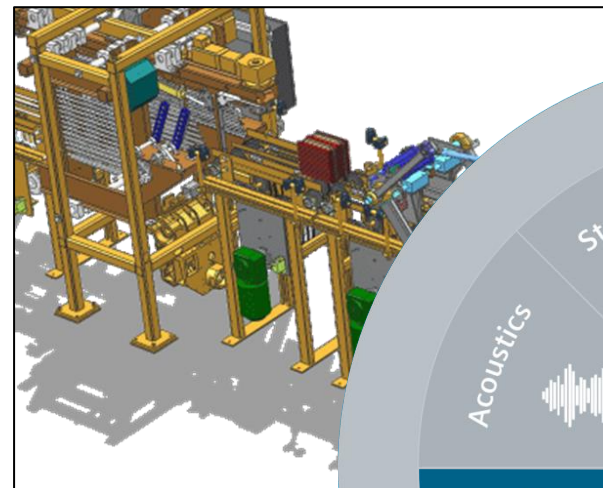
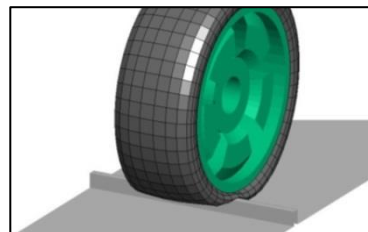
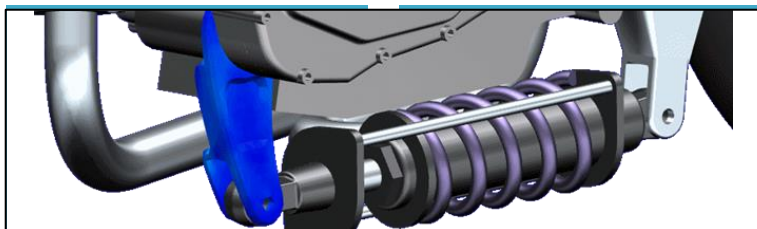

刚体  
柔体  
轮胎模型  
耦合1D和控制算法  
几何干涉检查

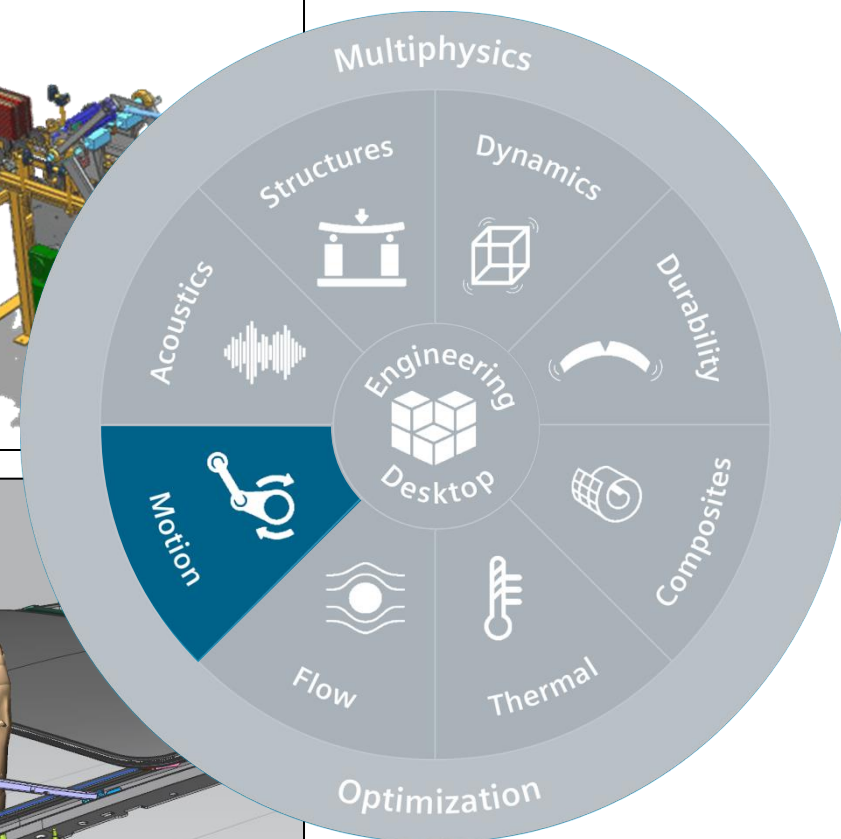

基于精确和稳定的多体动力学仿真方法对机电系统的位移、速度、加速度以及载荷进行预测、分析和改进。

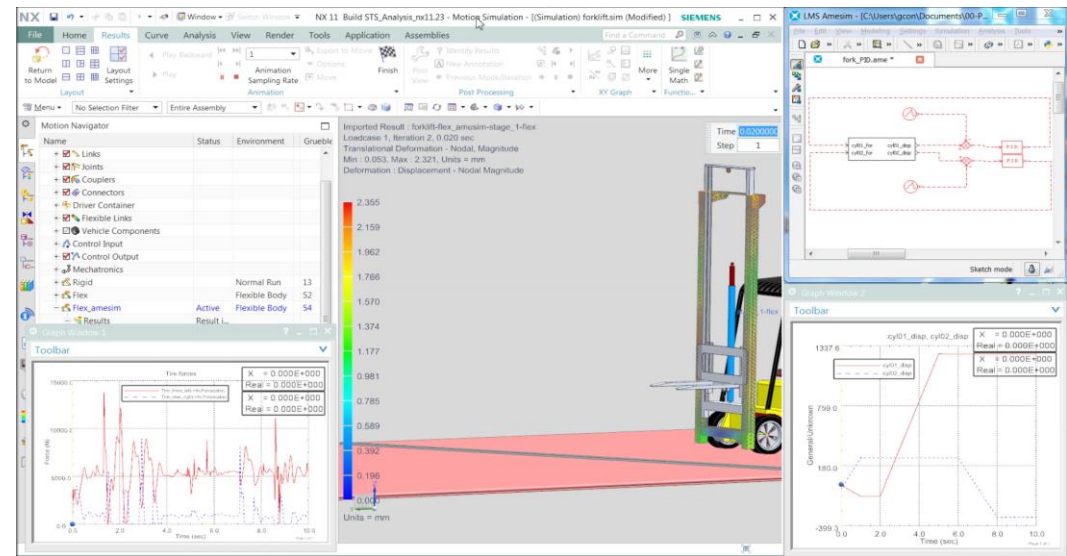

# Simcenter 柔性管路设计仿真

## 行业挑战

- 设计与实车的反复交互:柔性管路、橡胶软管、拉索线束等
- 运动过程中的实时干涉检查
- 最优管路长度
- 最合理的支撑个数位置选择

## Simcenter 柔性管路设计仿真功能

- 分析柔性管路在支撑结构有大位移大旋转运动过程中的实时包络
- 分析管路的振动特性及在特定激励下频域/时域的动态响应及随机振动分析

汽车制动管路

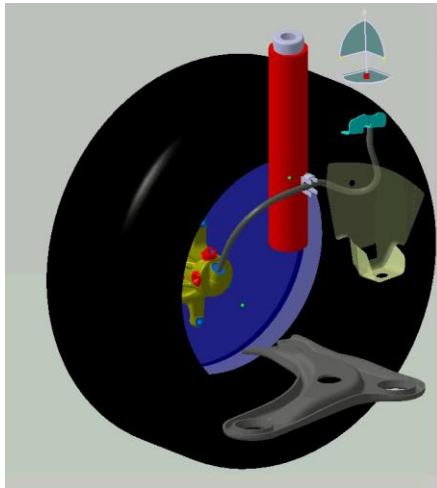

机器人控制臂的  
液压电缆

起落架的制动管路



# 声学仿真

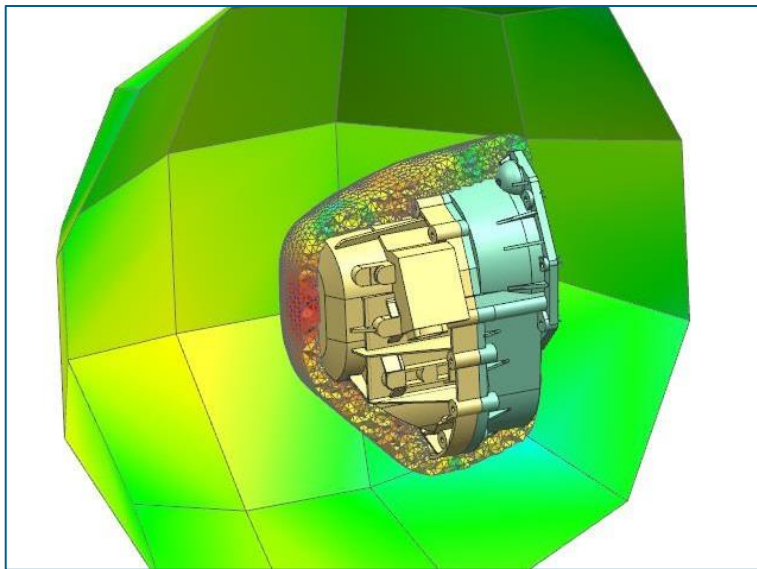
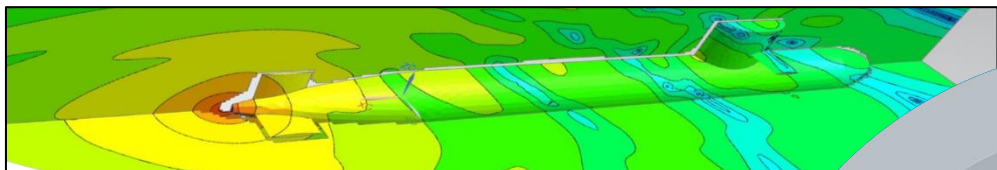
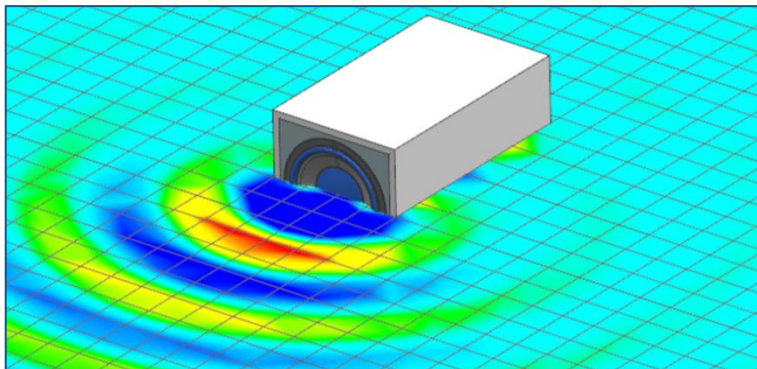

噪声辐射  
传递损失  
噪声防护  
声音扩散  
声学网格  
空气声学  
统计能量+

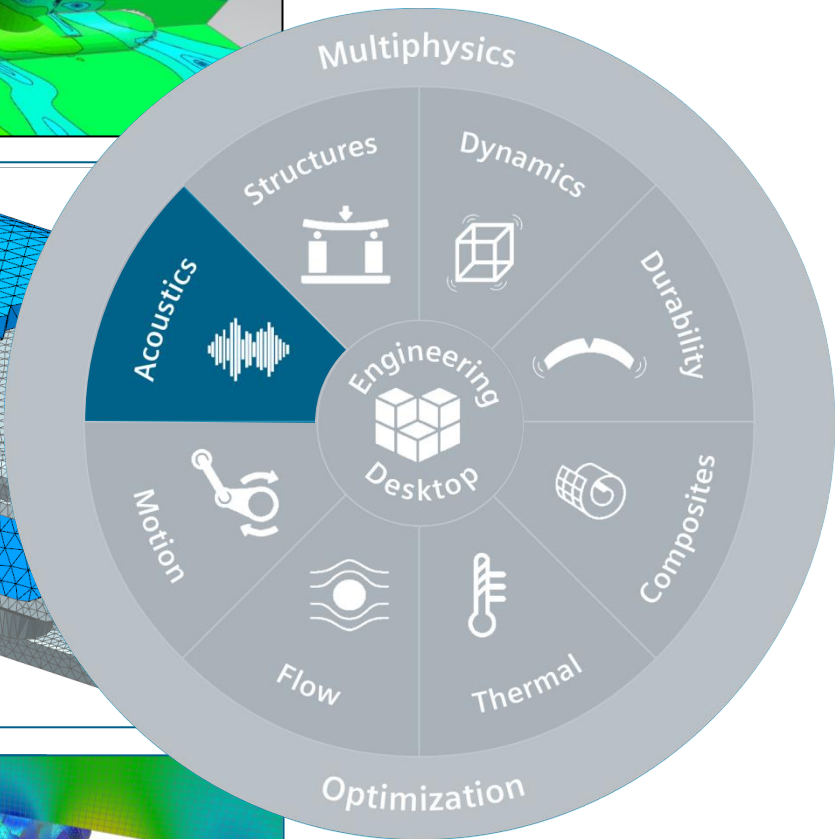
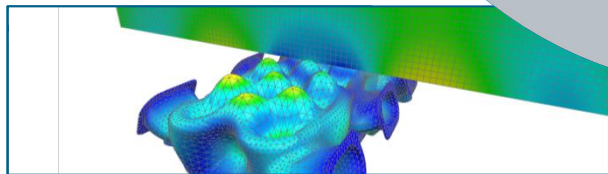
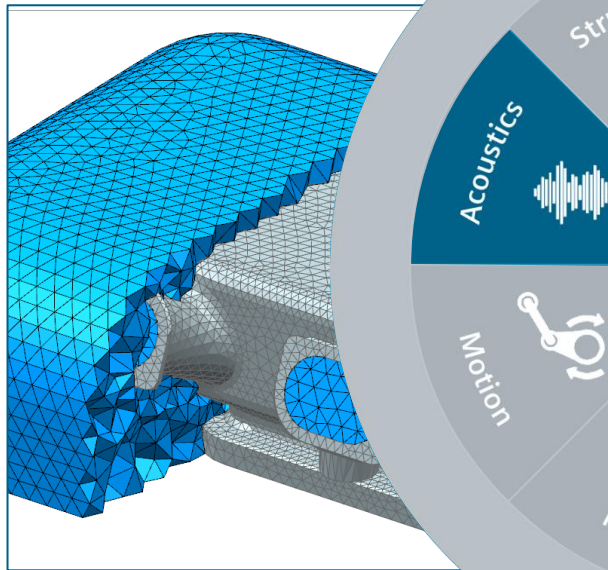

### 机械噪声辐射

(泵, 发动机, 压缩机, 电机,..)

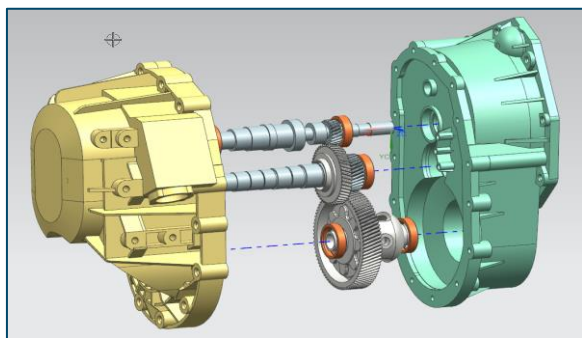

### 传递损失

(管道系统例如发动机进气系统)

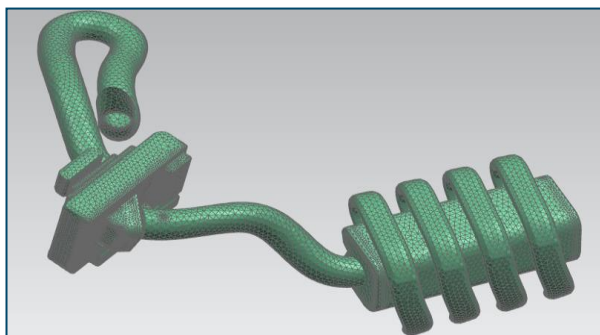

### 隔音罩

(机器,..)

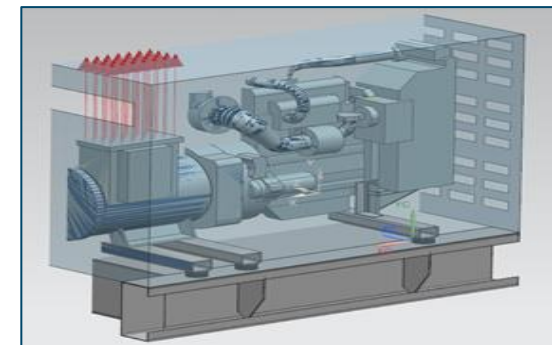

### 声学散射

(扬声器,..)

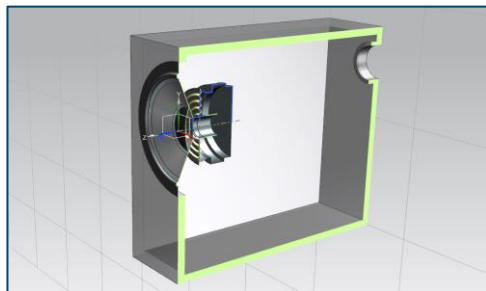

### 歧管壳体噪声辐射

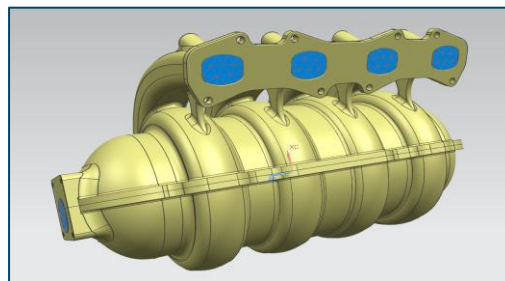

### 舱室噪声

(拖拉机, 挖掘机,..)





# Simcenter Acoustics

## 应用案例: 变速箱噪声

SIEMENS

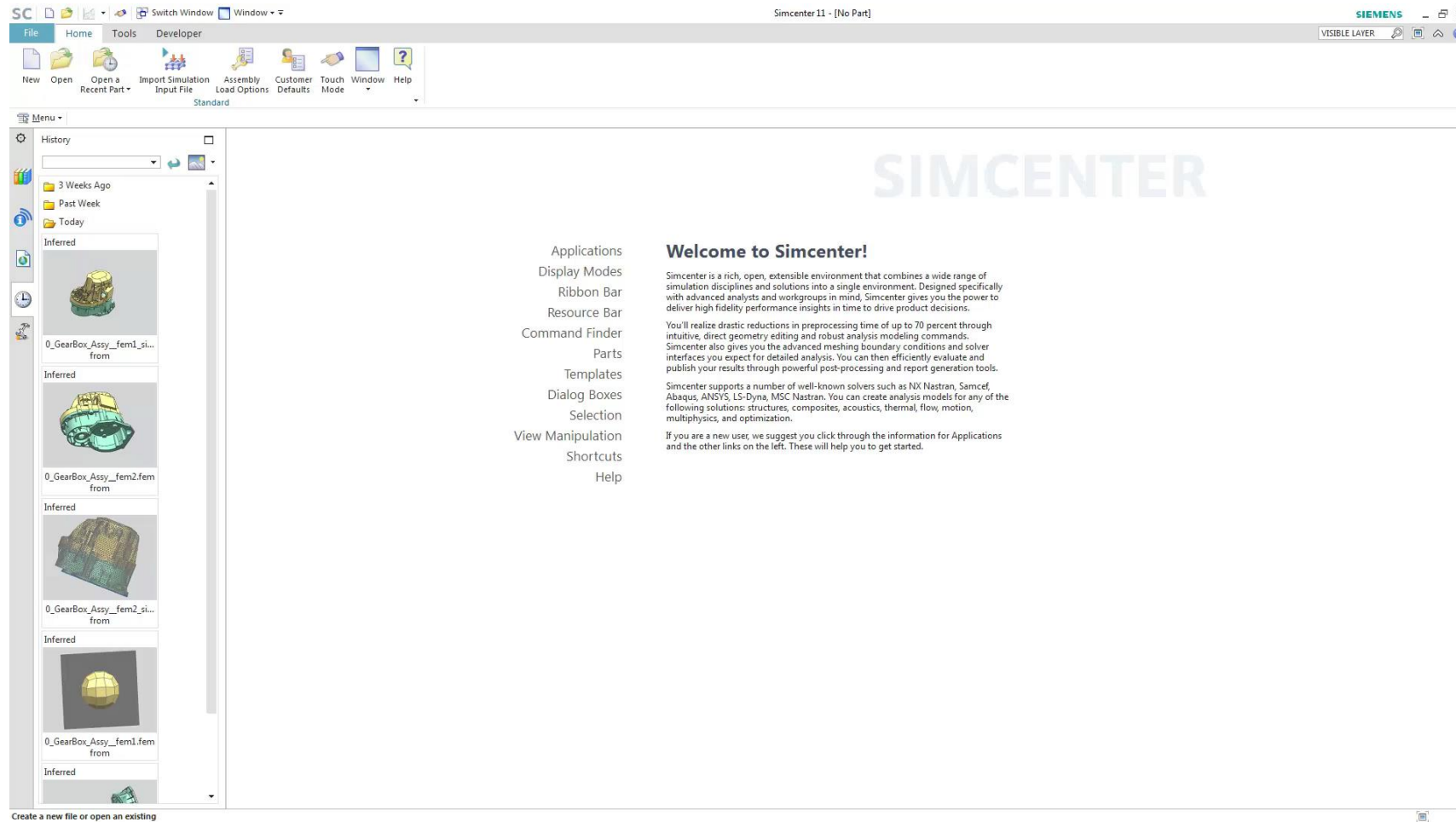

# 电磁场仿真

- **Electric Motors:** 电机  
Torque, Voltage, Losses,  
Deformation/Stress (+NX/Nastran),  
Temperatures

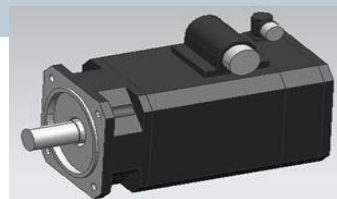

Servo-Motor 步进电机

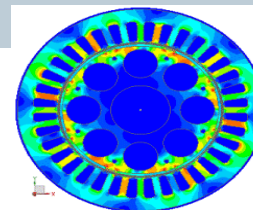

Flux-Density 磁通量

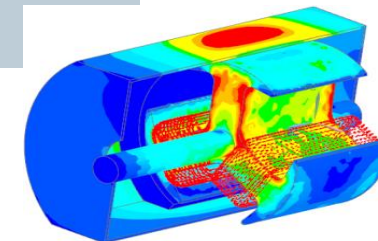

Transient 3D Rotation

- **Electromagnetic Compatibility** 电磁兼容分析:  
Eddy Currents 磁涡流, Losses 损失  
Temperatures 温度

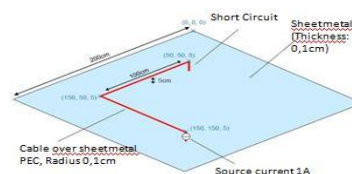

L-Cable near Sheet

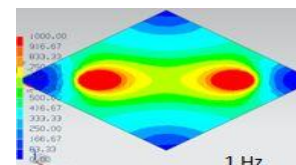

Eddy-Currents 1Hz

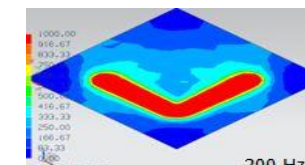

Eddy-Currents 200Hz

- **High-Power-Conductors:** 高功率导体  
Electric Potential, Forces  
Deformation (+NX/Nastran)  
Temperatures



Feedthrough 直通

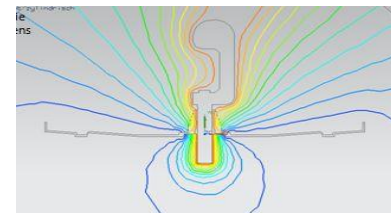

Potential 电势力

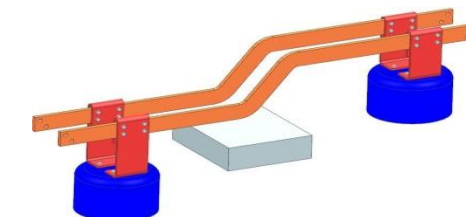

Two Conductors

- **High-Frequency:** 高频  
Antennas and Wave Guides: 天线  
SWR 驻波比, Directivity, Gain, Efficiency,  
S-Parameters

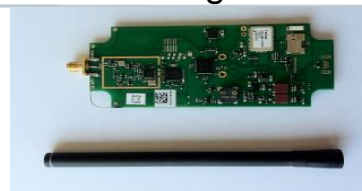

Antenna with PCB

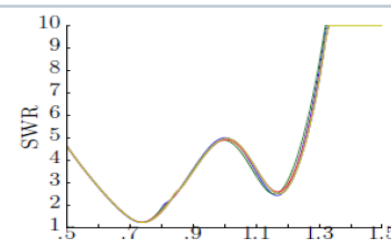

SWR(Freq)

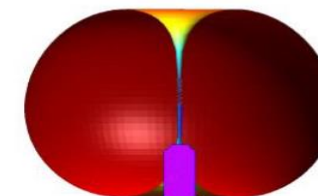

Directional Diagram 天线阵方向图

# 多物理场耦合分析

热机耦合

热流耦合

流固耦合

声固耦合

运动-结构耦合

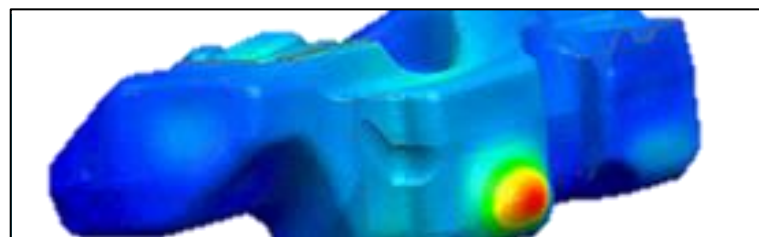
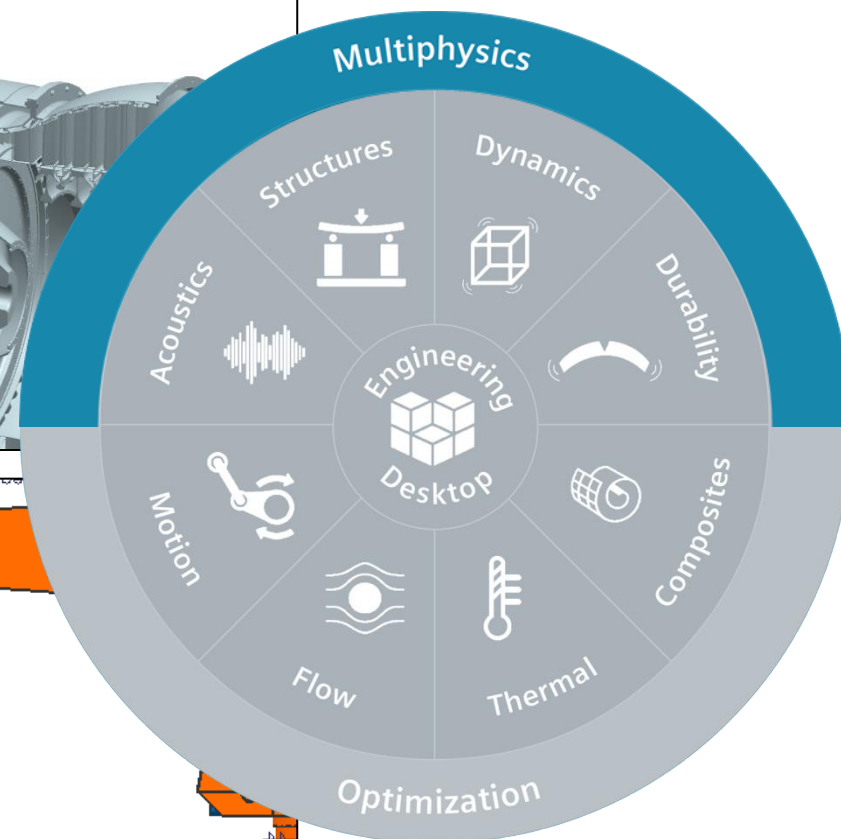
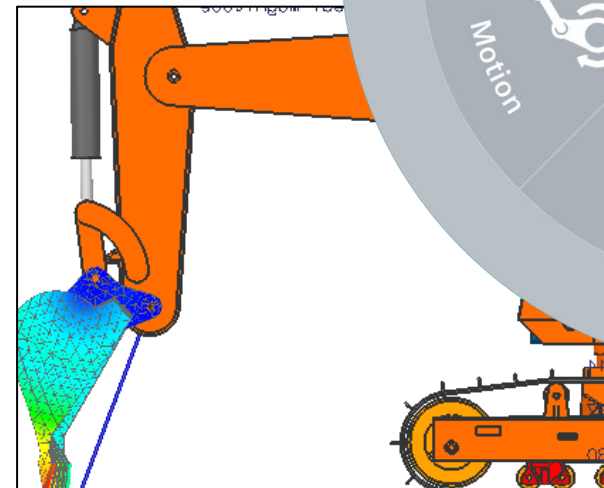
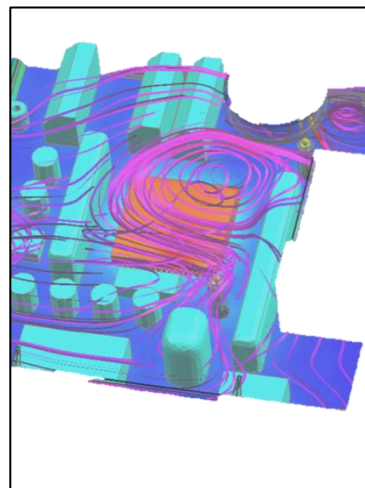
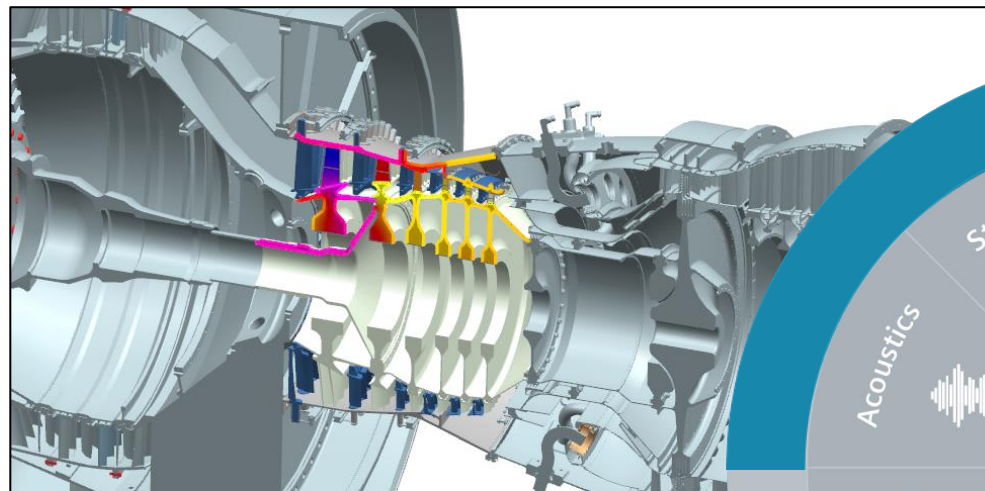

# 优化设计

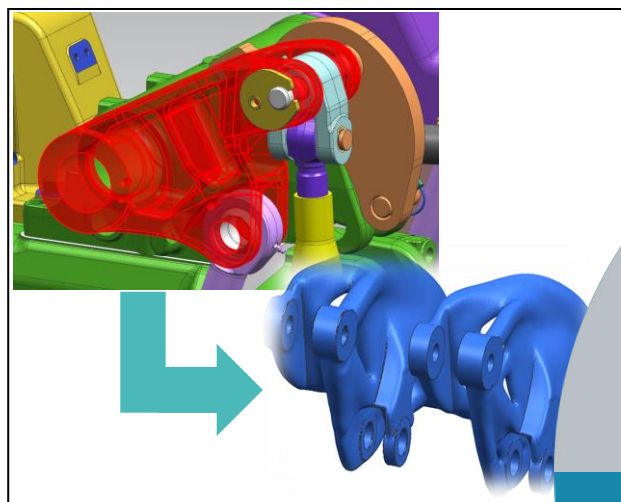
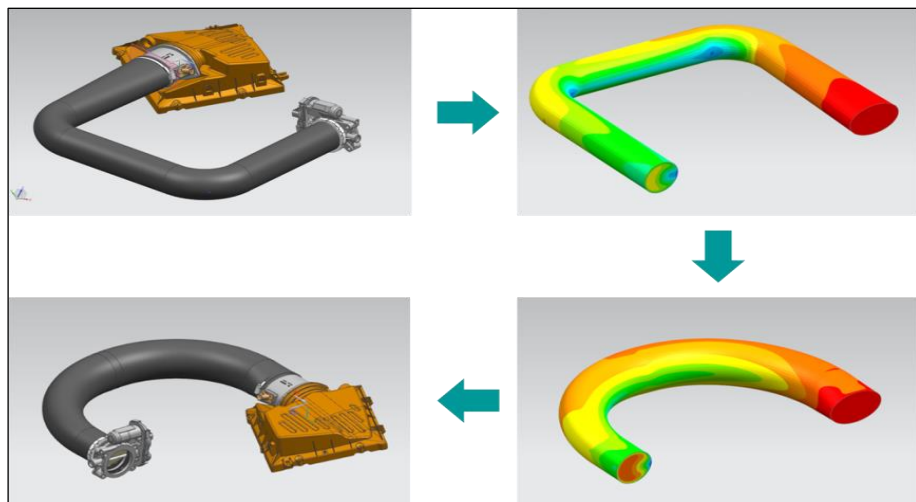

几何优化  
有限元参数优化  
拓扑优化  
HEEDS多学科优化

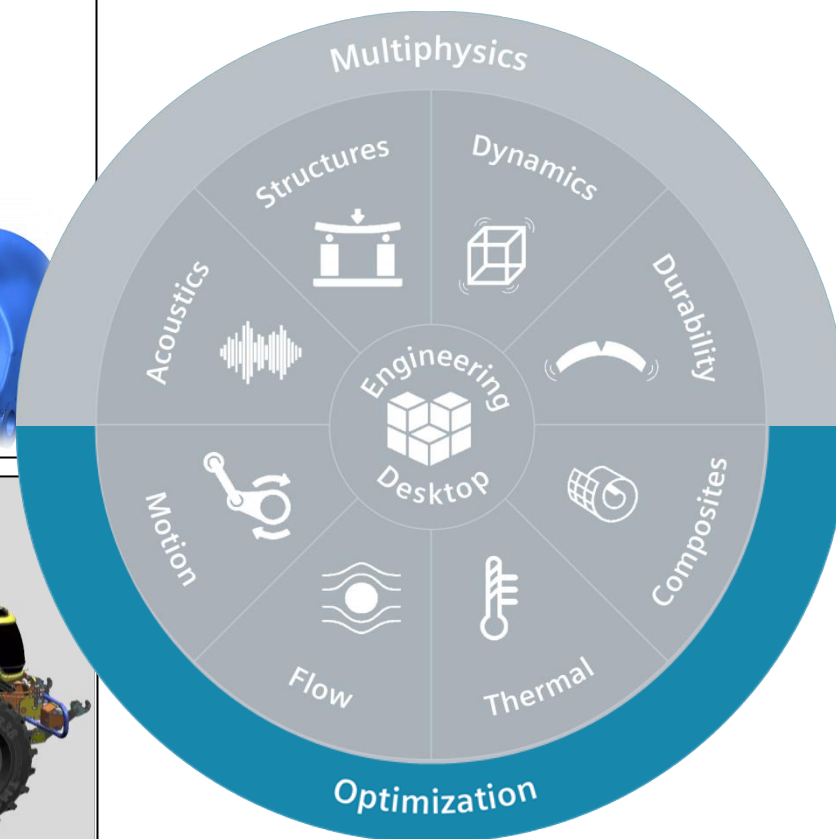
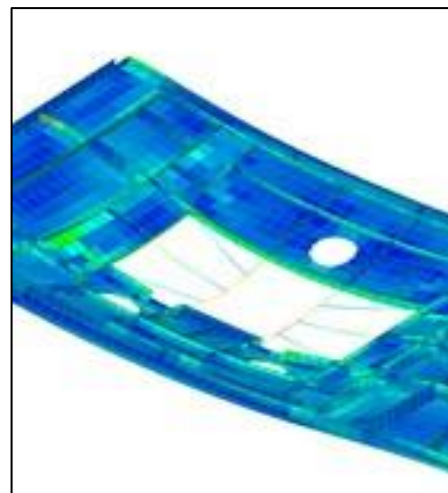

# Simcenter™ 产品系列用于预测性工程分析 HEEDS – 多学科设计探索

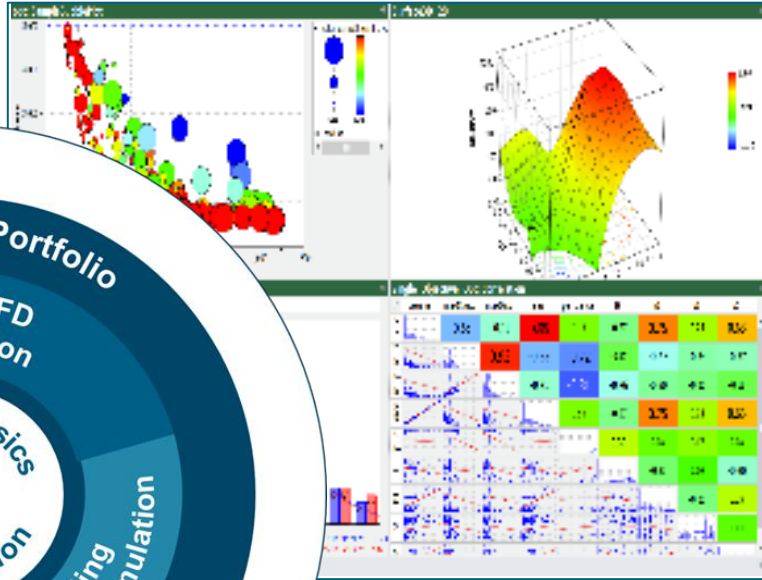
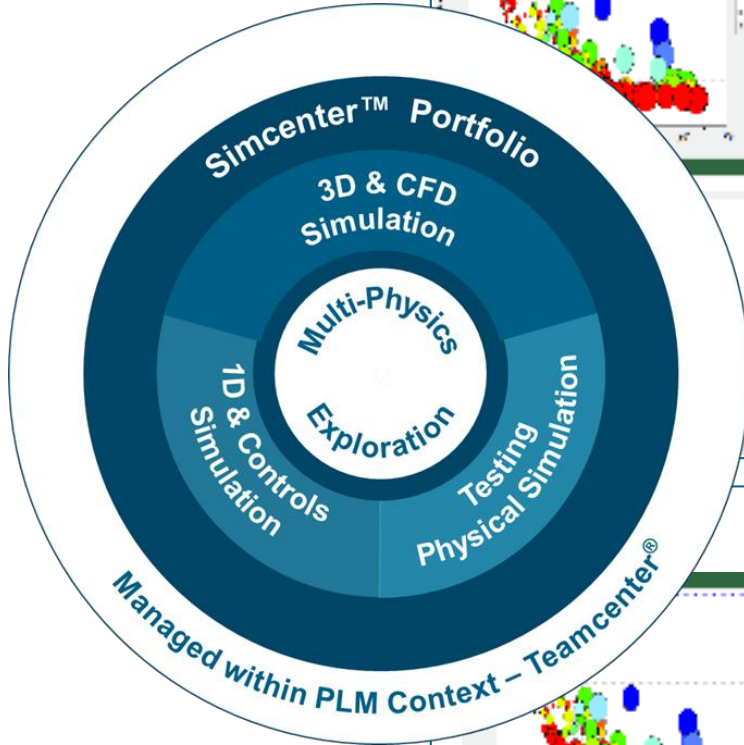

HEEDS

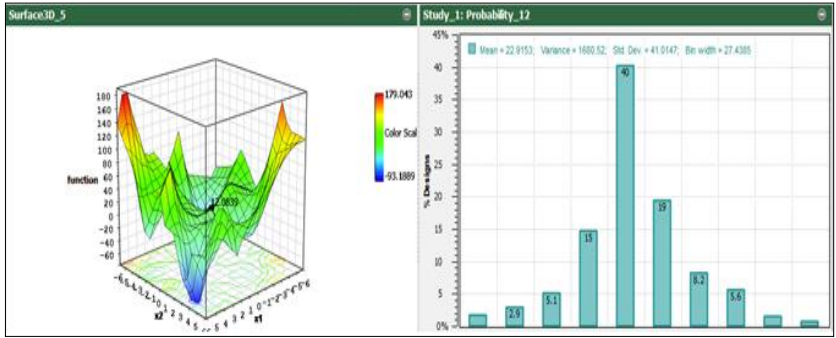
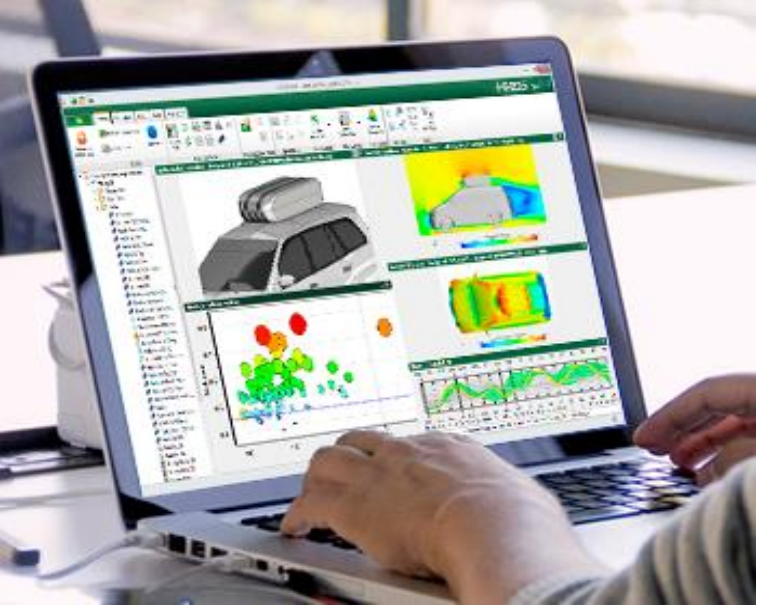
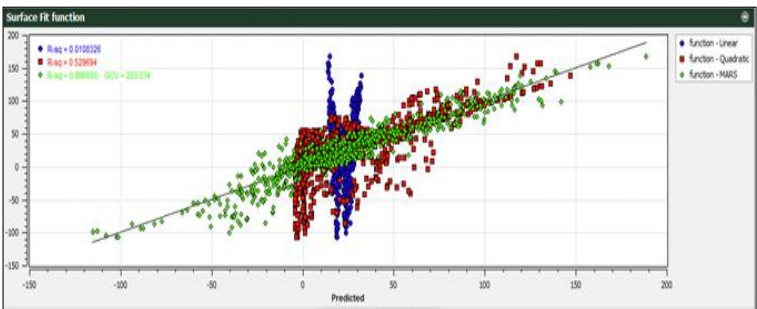

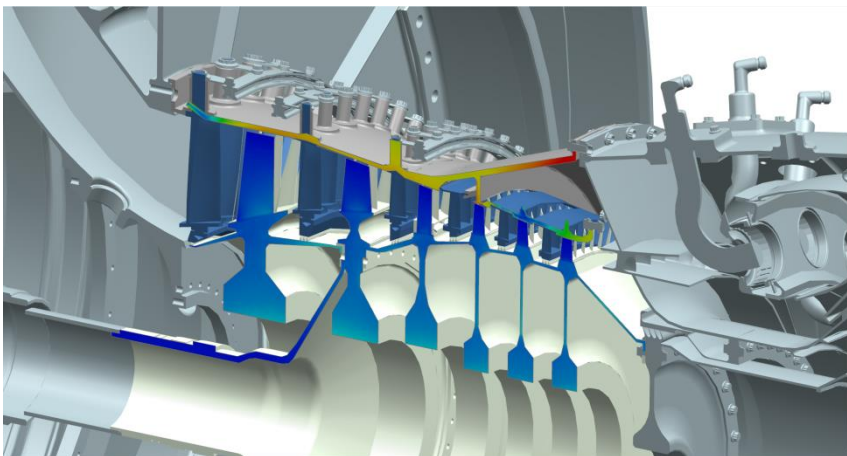

### 认识到西门子方案的优势

几何简化, 模型创建,  
热分析,  
结构分析和多学科分析,  
方案扩展和开发性

### 利用设计和仿真的集成迭代, 加速新品的上市周期

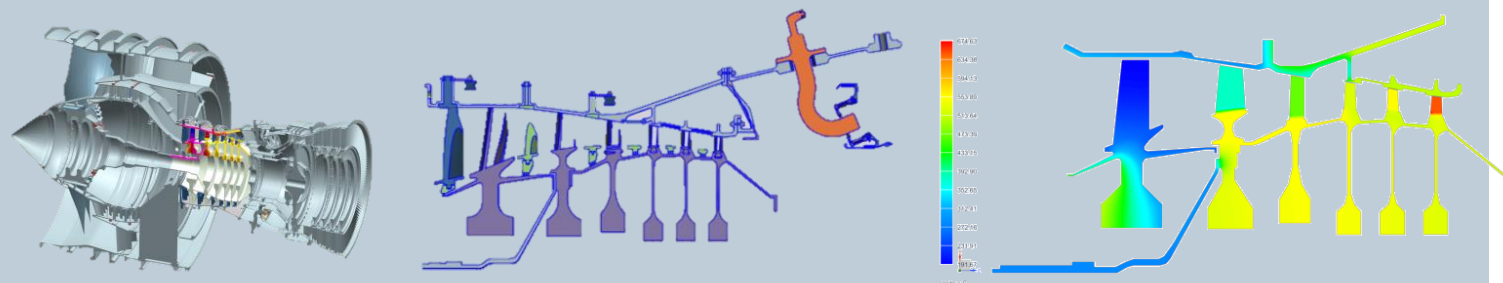

数据管理&  
关联几何模型

快速的多学科  
建模和仿真

早期的认知  
加速创新

**“我们决定将Simcenter 3D作为公司开展有限元分析的标准程序”**

Ed Green , Chief of Mechanical Methods, Source: NX CAE Symposium

最佳的仿真建模工具

多学科仿真集成

开放性和可扩展性

领先的系统仿真

行业专家知识

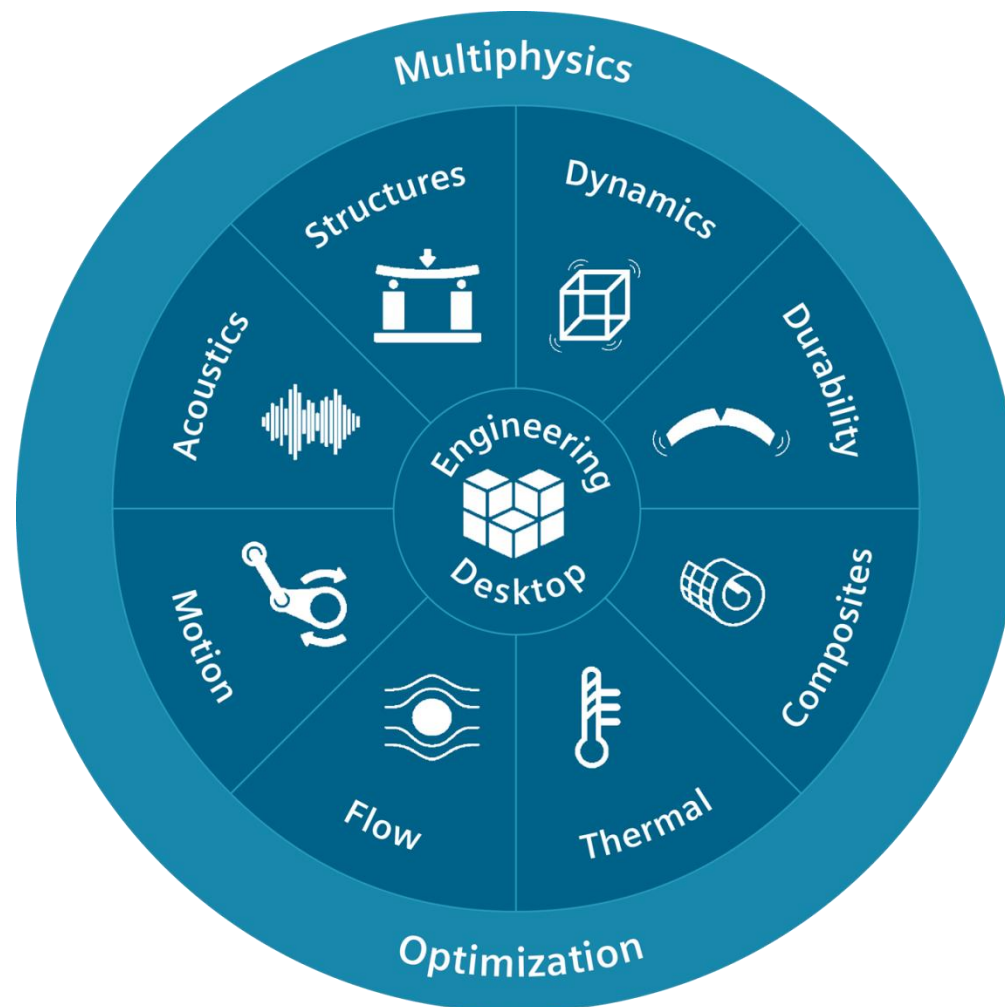

# Simcenter™ 3D 开放的、可扩展的仿真平台

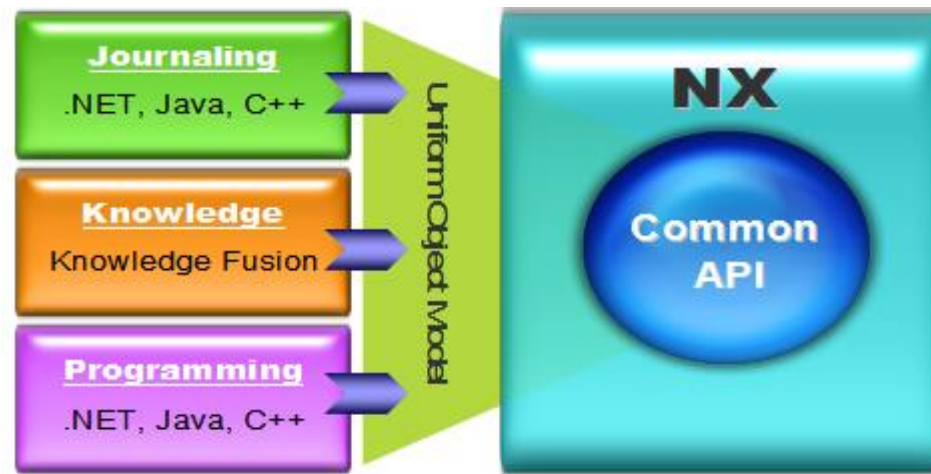
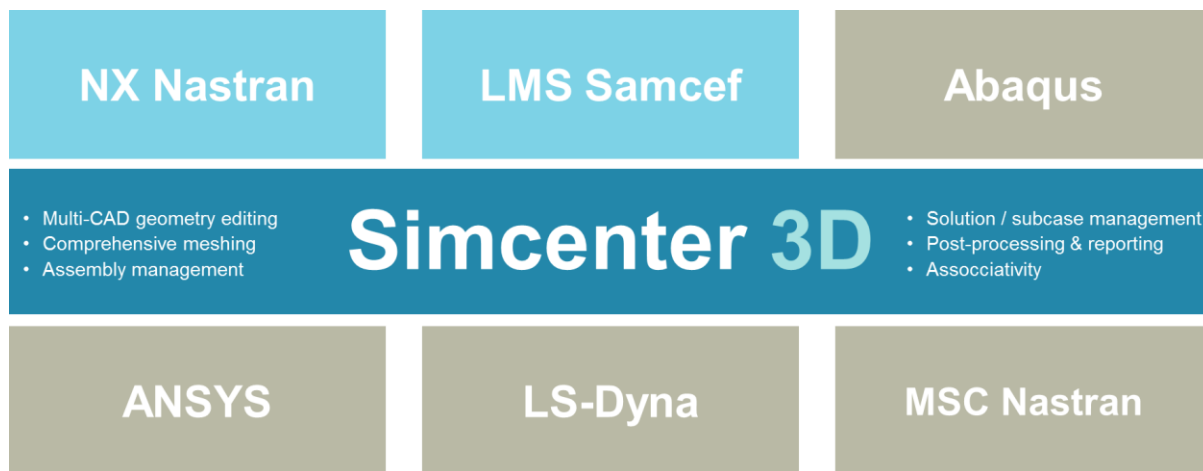

## 多学科仿真和报告



## 捕捉流程和自动化定制

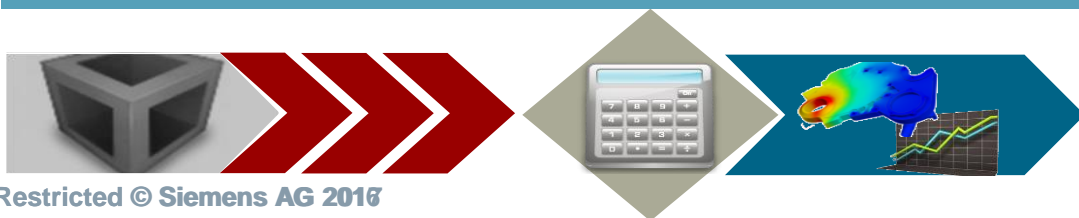



## 适合所有层面的仿真工程师

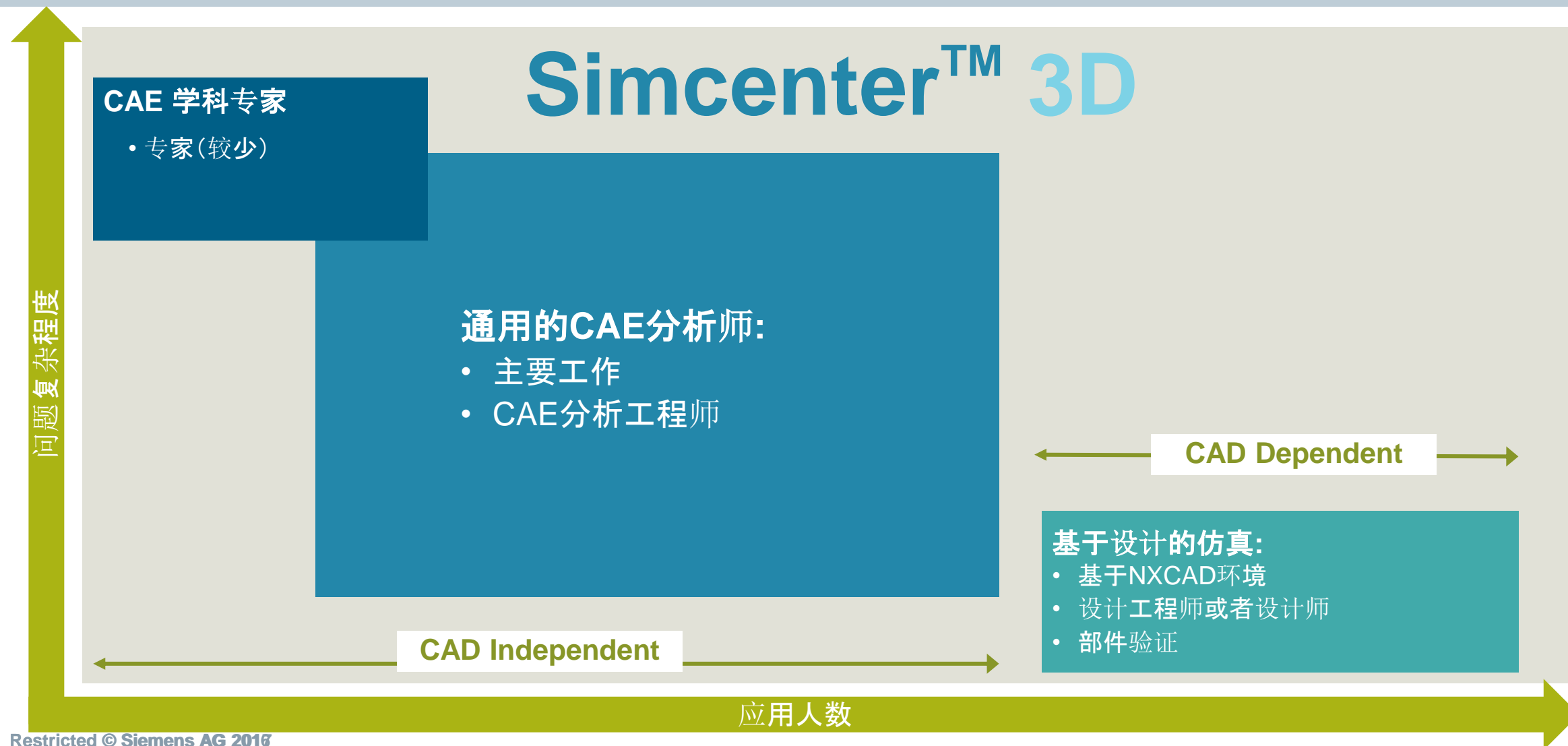

最佳的仿真建模工具

多学科仿真集成

开放性和可扩展性

集成的系统级仿真

行业专家知识

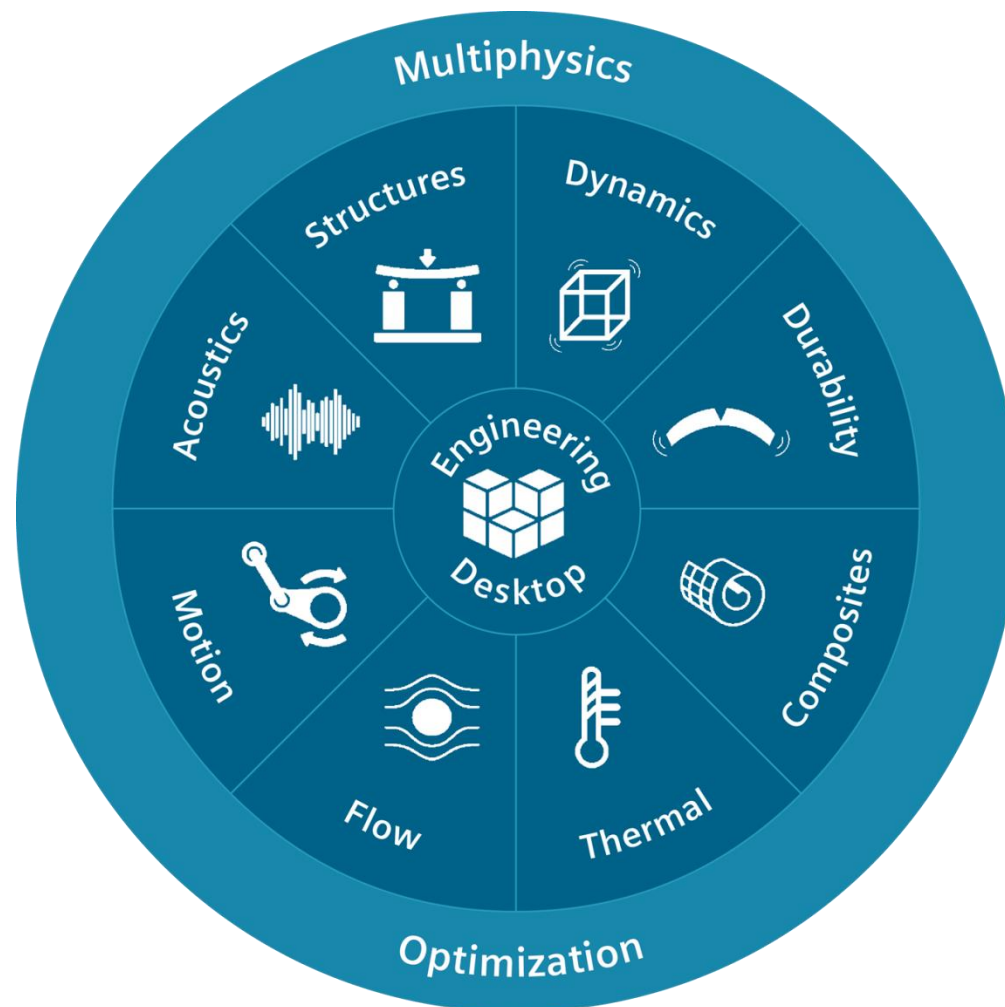

# Simcenter™ 产品系列用于预测性工程分析 实现闭环系统驱动的产品开发



## LMS Imagine.Lab

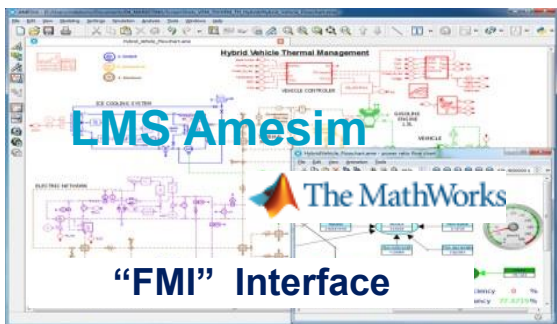

## Simcenter 3D

NX CAE, LMS Virtual.Lab,  
LMS Samtech Suite  
NX Nastran

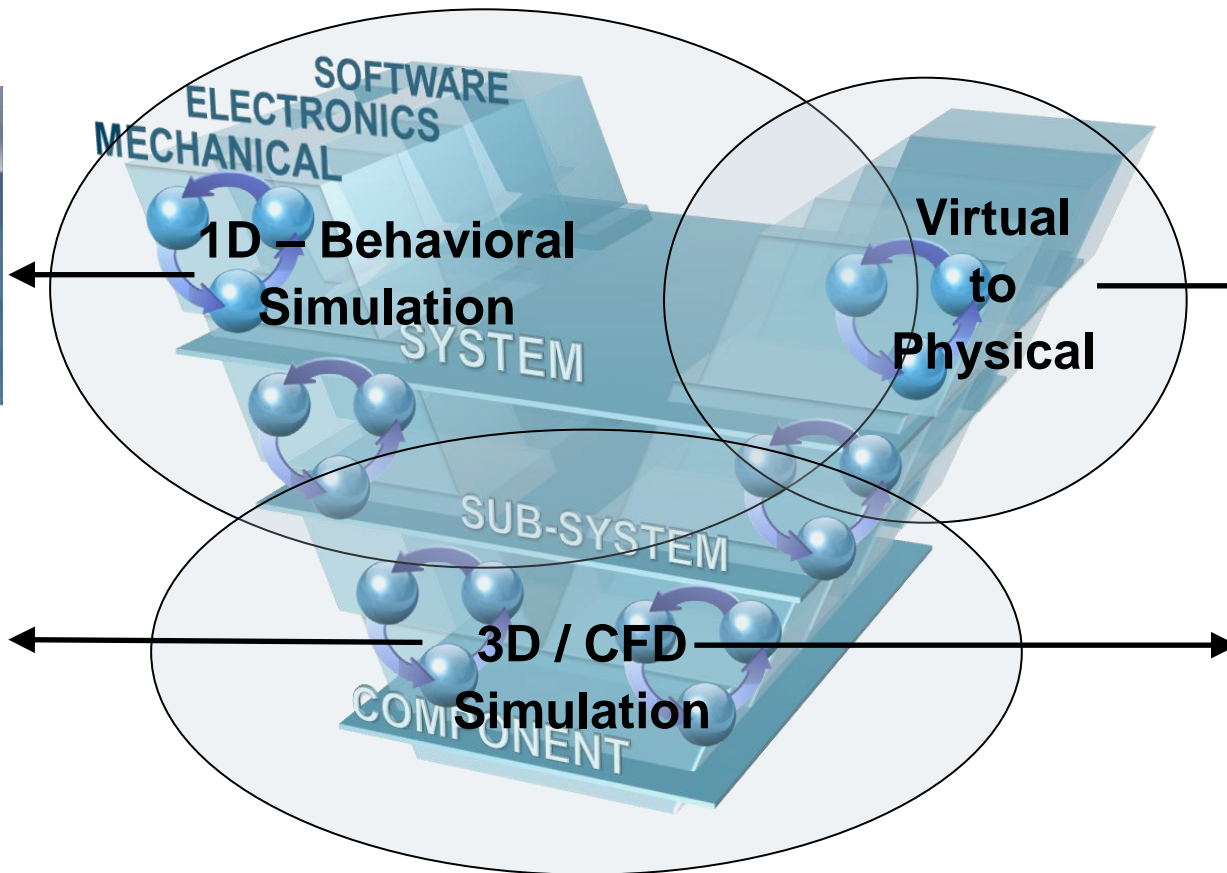
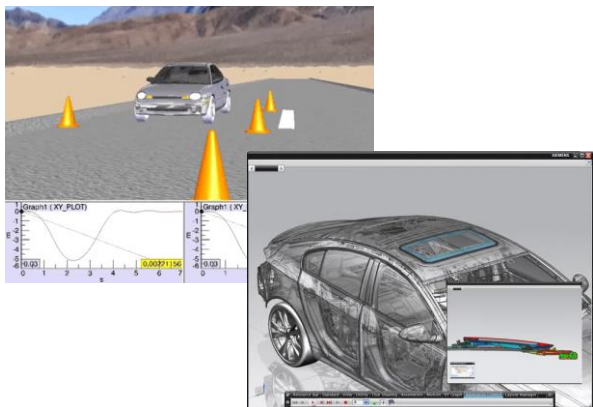

## LMS Test.Lab



## CD-adapco STAR-CCM+

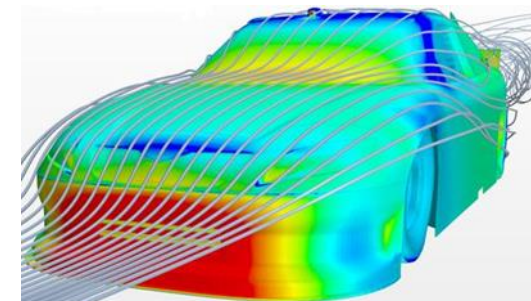

弹性的一维-三维仿真包括实时  
从虚拟到实物

# 系统确认和优化 Simcenter 3D 和 Imagine.Lab联合仿真

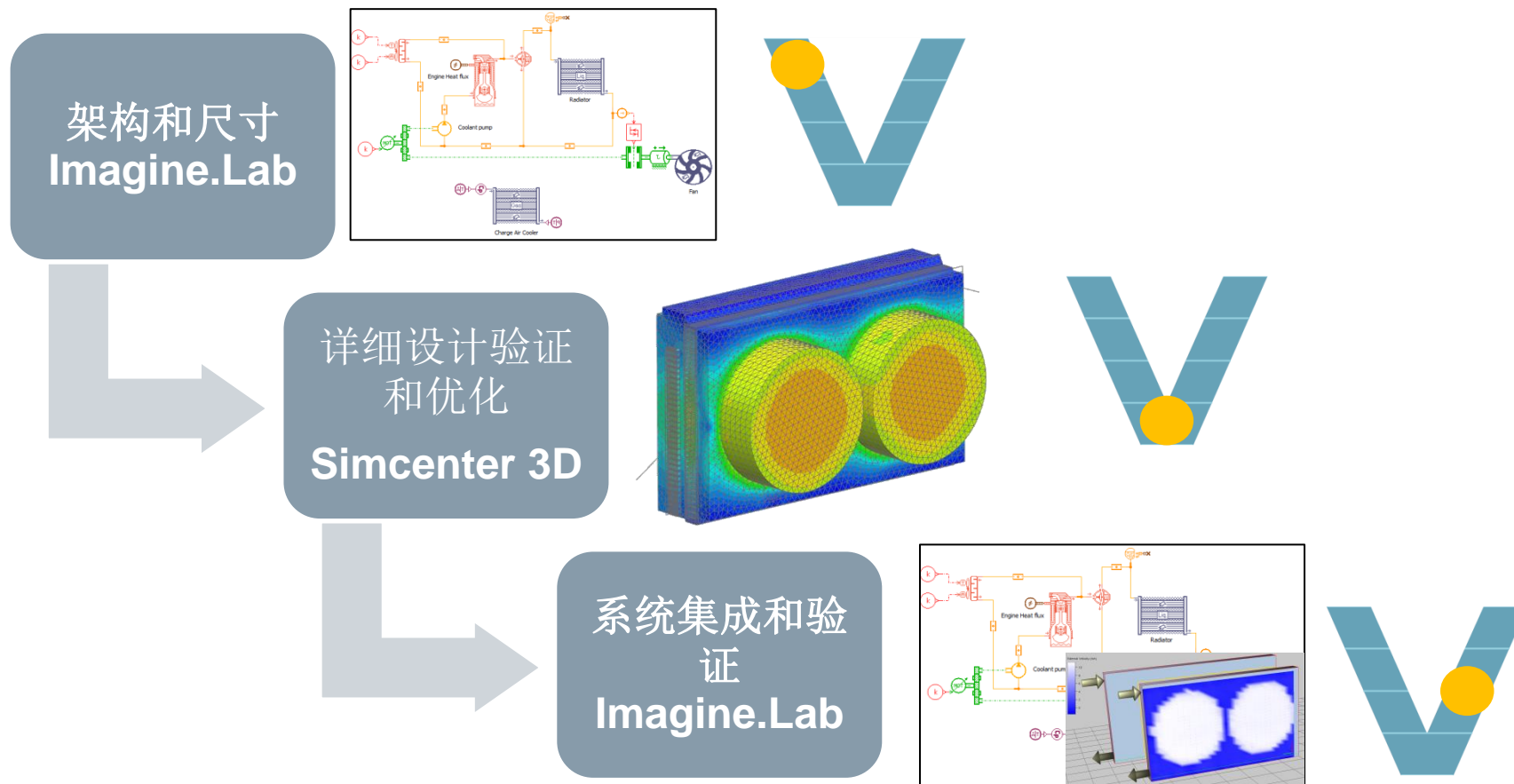



# 戴姆勒奔驰 可标量的机电系统仿真 – 离线和实时



## 优化车辆设计提高驾驶乐趣

操控, 舒适性, 疲劳

联合车身控制  
(ESP, ABS,...)

前端控制算法开发

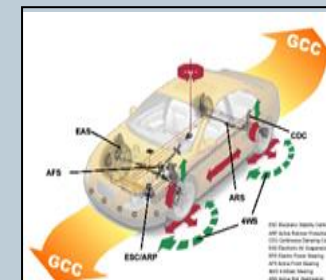
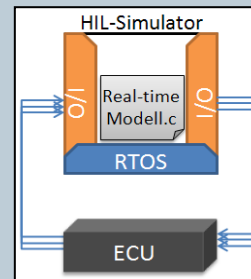
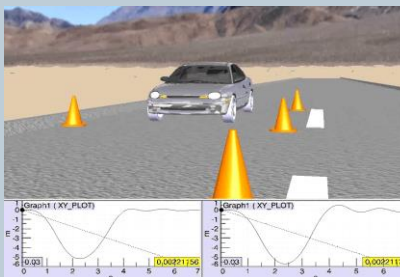

## 离线仿真

(1) 车辆设计优化  
操控, 舒适性, 疲劳

## 实时仿真

(2) 前端控制算法  
车身控制 – 主动安全

“车辆操纵稳定性, LMS Virtual.Lab Motion 是非常有力的开发工具。  
应用LMS Virtual.Lab 开展硬件在环仿真(实时), 在整个仿真过程可以采用统一的模型数据。”  
Prof. Ludger Dragon, Senior Manager Vehicle Dynamics Integration Division, Daimler

最佳的仿真建模工具

多学科仿真集成

开放性和可扩展性

领先的系统仿真

行业专家知识

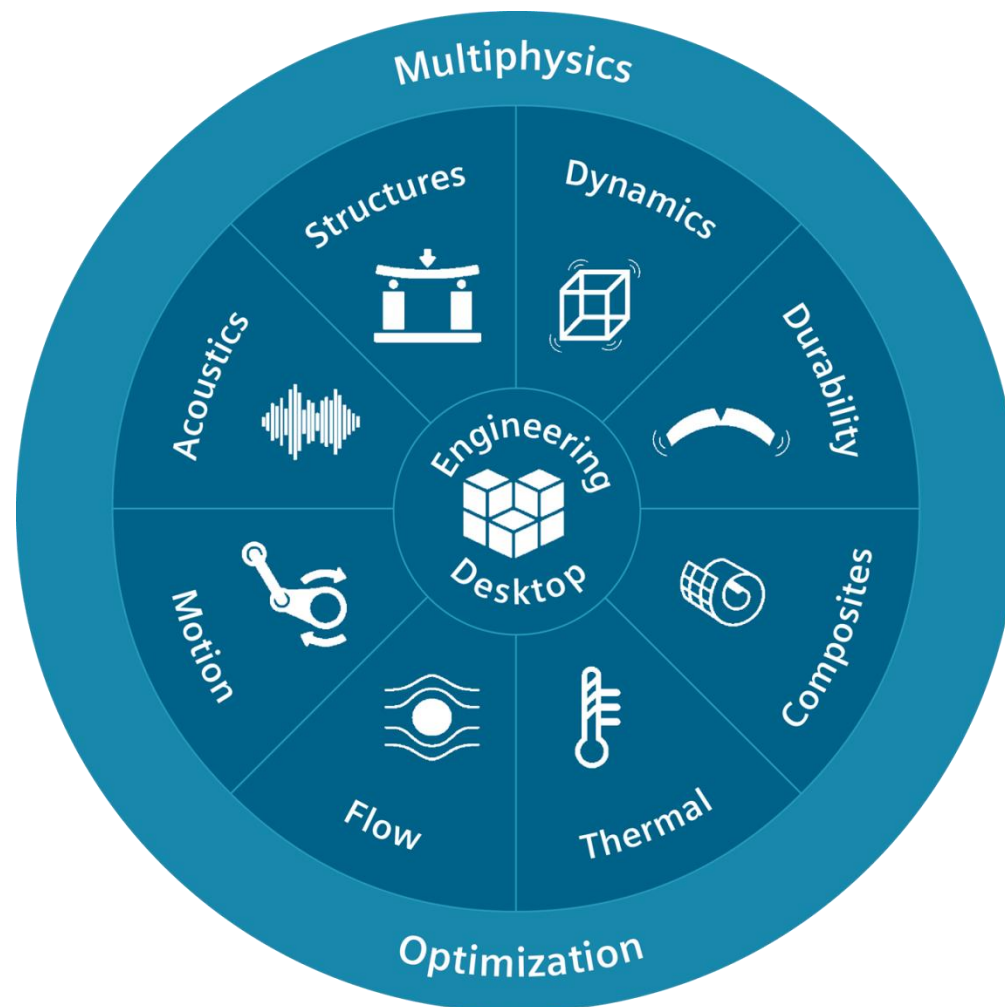

嵌入行业专家知识

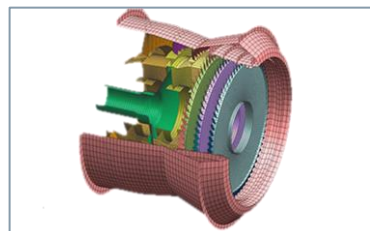

转子动力学

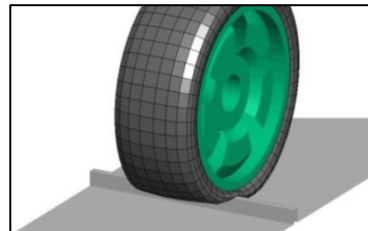

轮胎模型

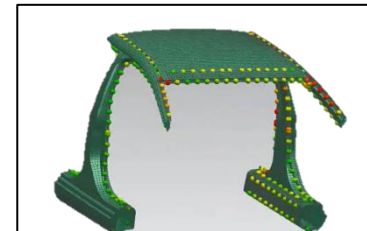

焊点处理

风机方案

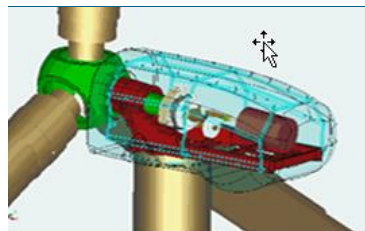

电子系统冷却

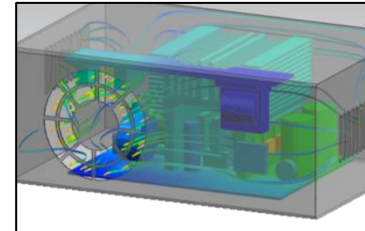

随机结构噪声耦合

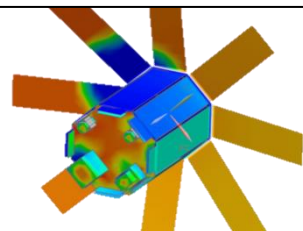

空间系统热

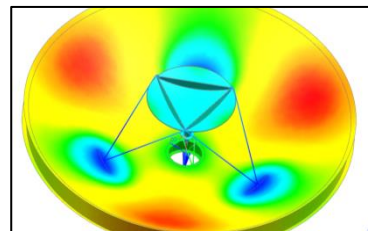

响应仿真

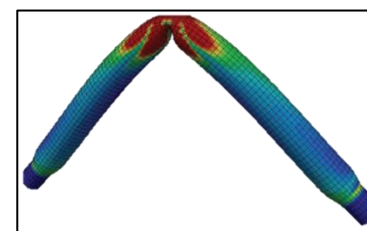

柔性管路

复合材料

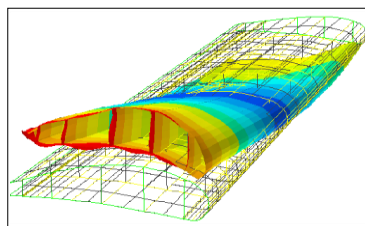

航空结构强度

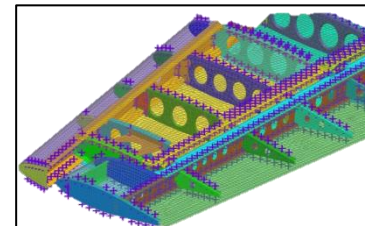

声学

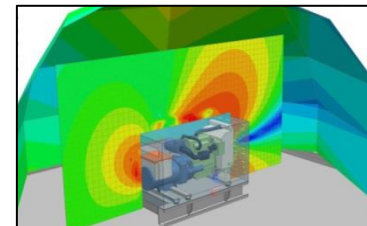



# 工程咨询 – LMS & CD-adapco

## 利用行业 and 全球智力, 为客户创造价值



解决问题  
合作开发  
技术转让  
工程过程转化

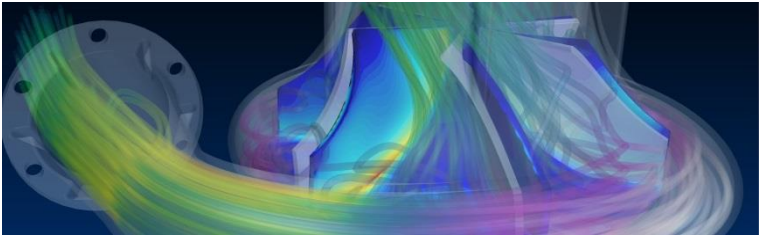

性能工程  
噪声、振动  
疲劳  
燃料消耗  
机电系统开发  
CFD  
燃烧

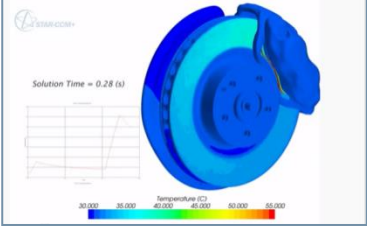
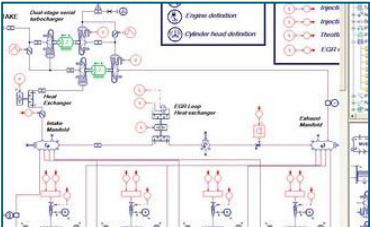
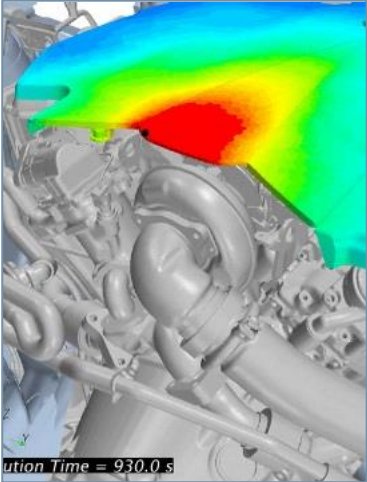

# Simcenter™ 产品系列用于预测性工程分析 STAR-CCM+

SIEMENS

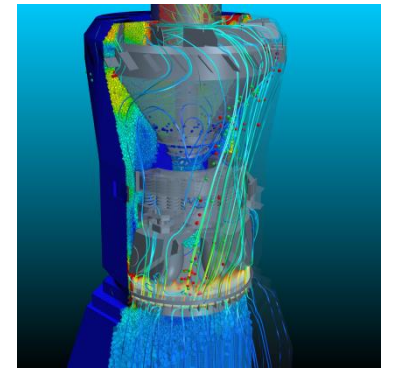
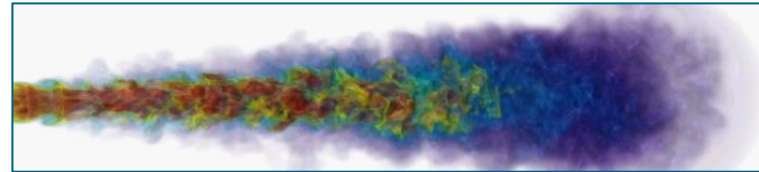
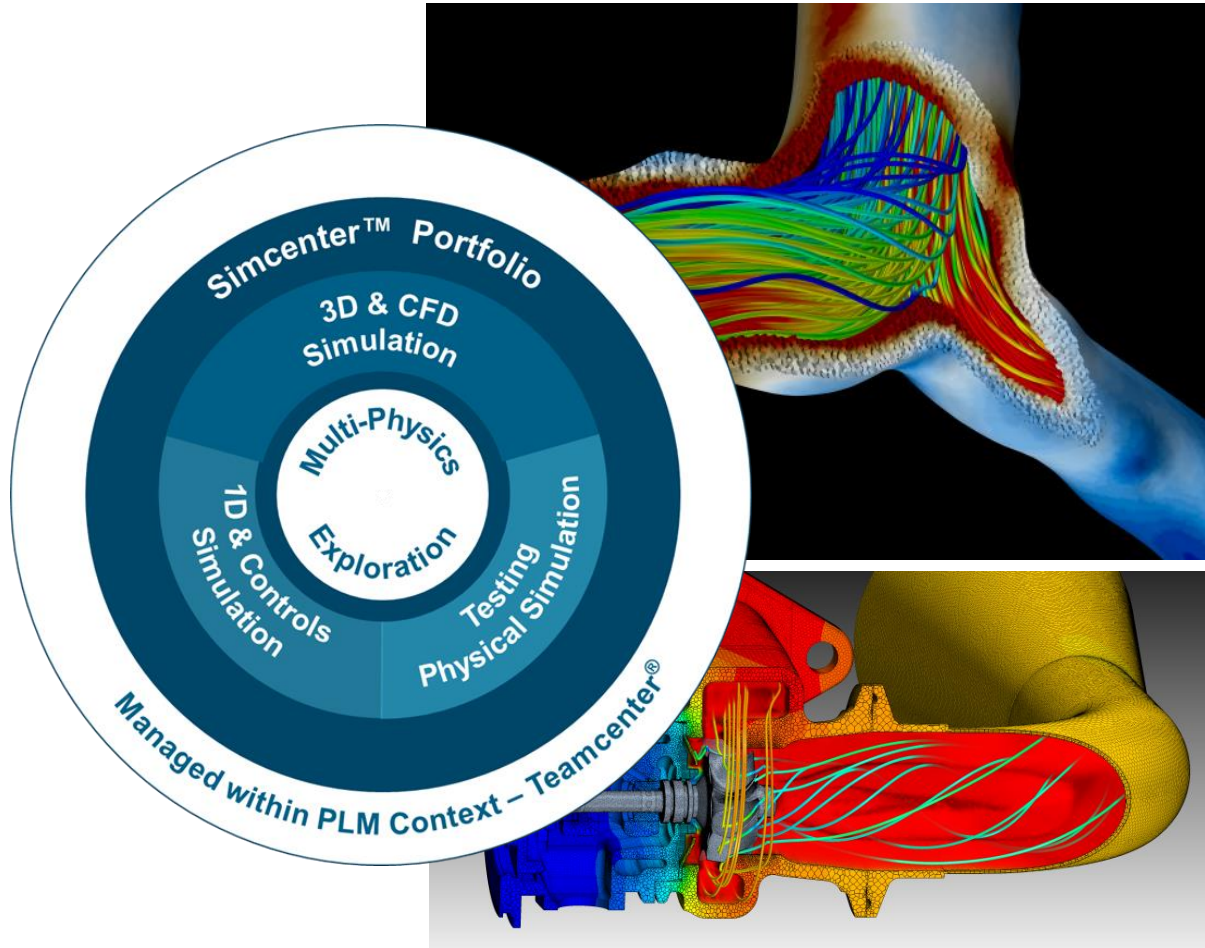

STAR-CCM+

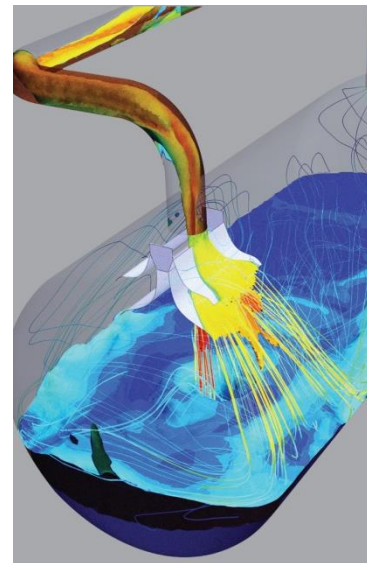

# Simcenter™ 产品系列用于预测性工程分析 STAR-CCM+

SIEMENS

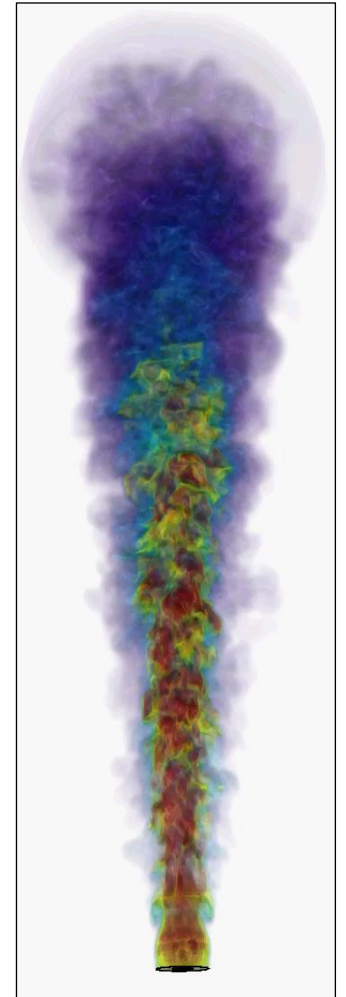
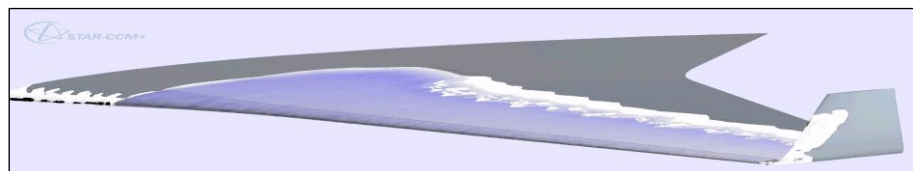
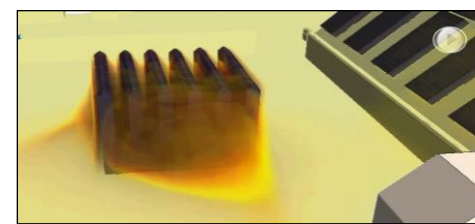
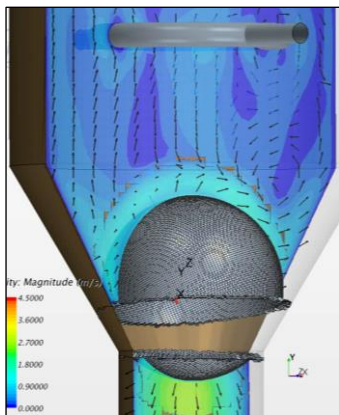
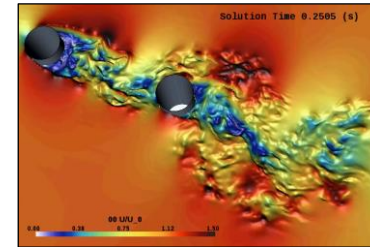
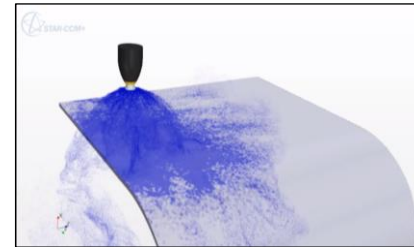
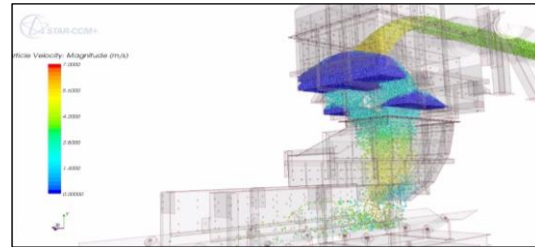
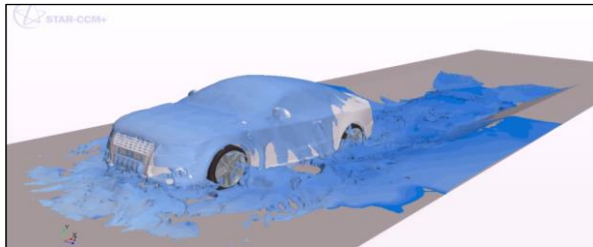
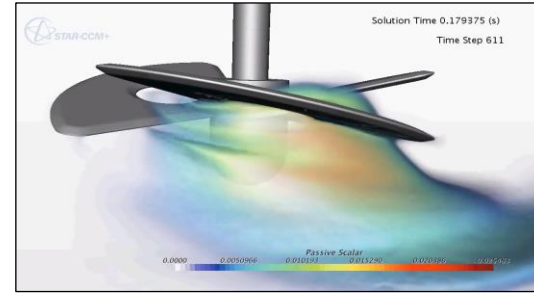
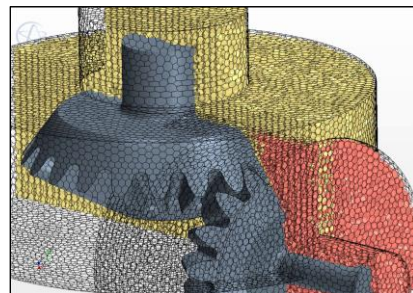
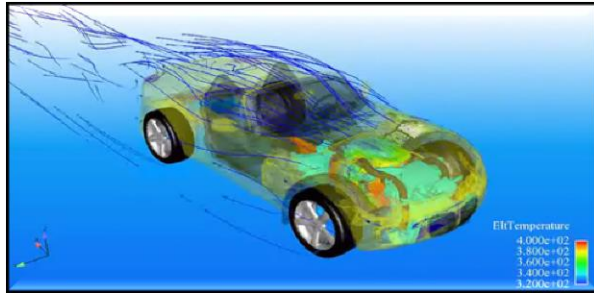

# 应对预测性工程分析的解决方案-- Simcenter™ Portfolio

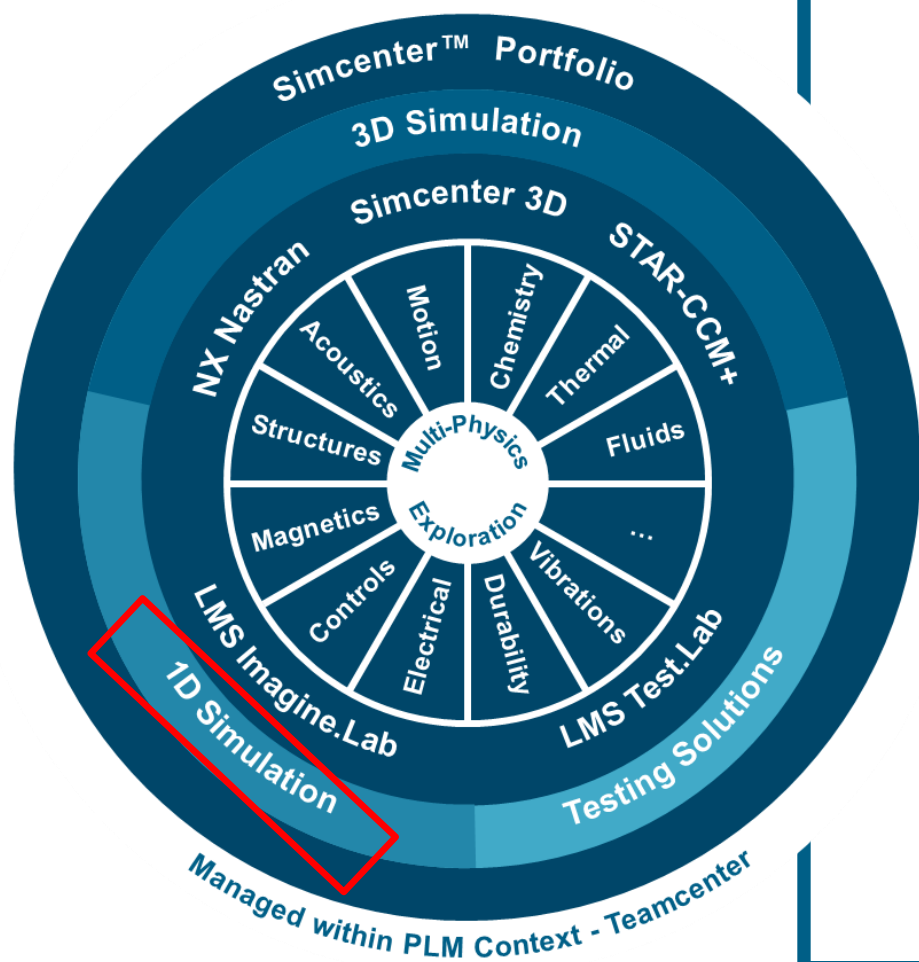

# Simcenter™ 1D仿真方案

# Simcenter™ 产品系列用于预测性工程分析 1D仿真 ( LMS Imagine.Lab ) 概念阶段的多学科仿真

SIEMENS

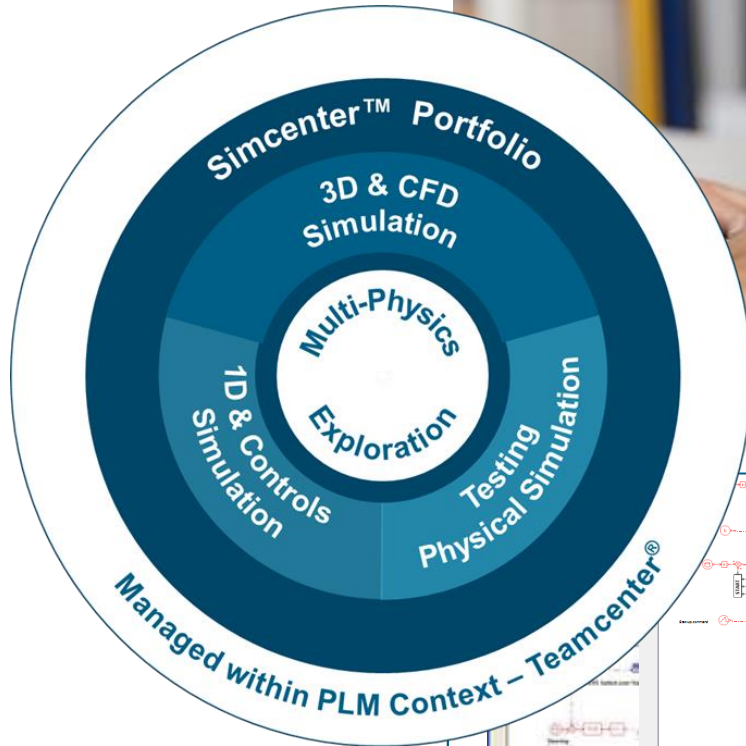

## LMS Imagine.Lab Amesim

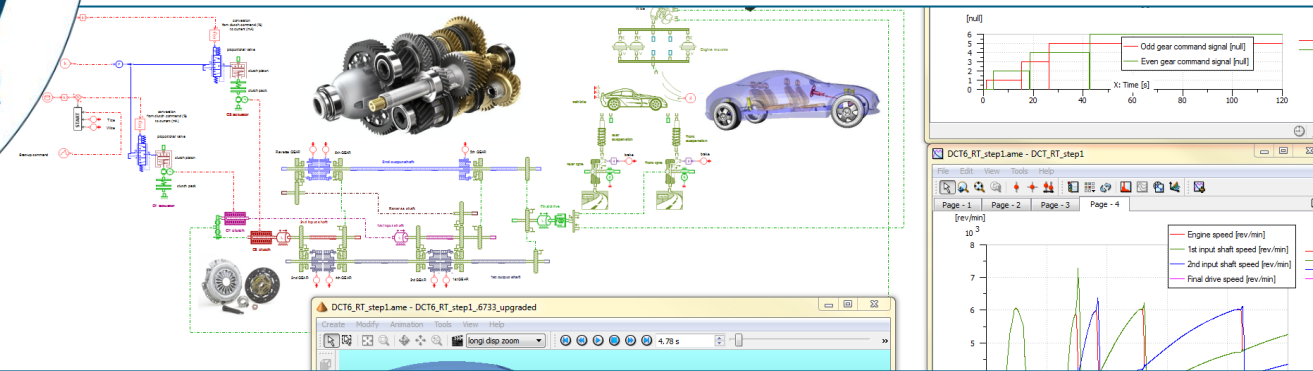
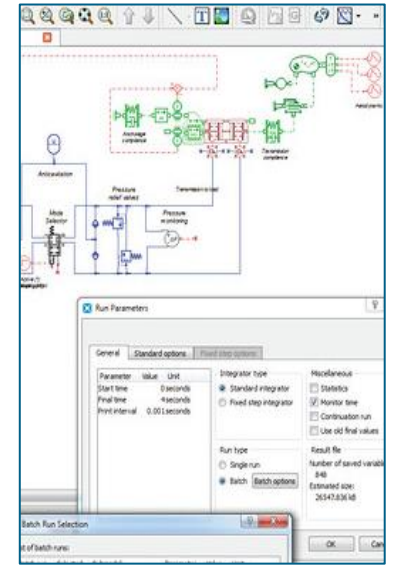
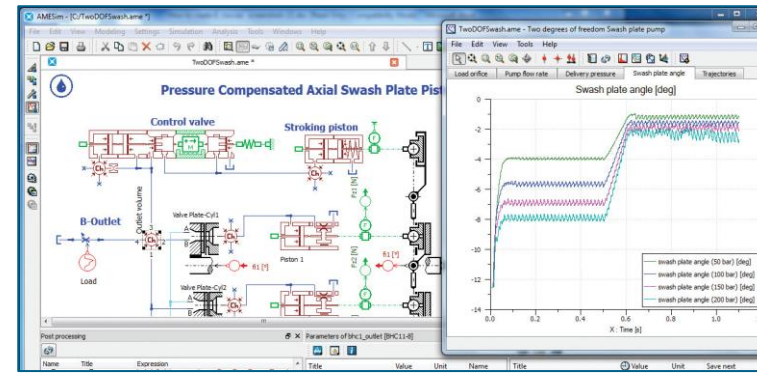

## LMS Imagine.Lab System Synthesis

# Simcenter™ 产品系列用于预测性工程分析 1D仿真 ( LMS Imagine.Lab ) 概念阶段的多学科仿真

SIEMENS



基于模型的系统测试

## 行业专业库

- 内燃机
- 传动
- 热系统
- 车辆动力学
- 电气系统
- 起落架&飞控
- 发动机设备
- 环控系统
- 燃油系统
- 多电飞机
- 泵&压缩机
- 电液阀
- 流体作动系统
- 热交换器
- 热泵/制冷

## 概念设计

系统分解 & 集成

多属性平衡

控制策略验证

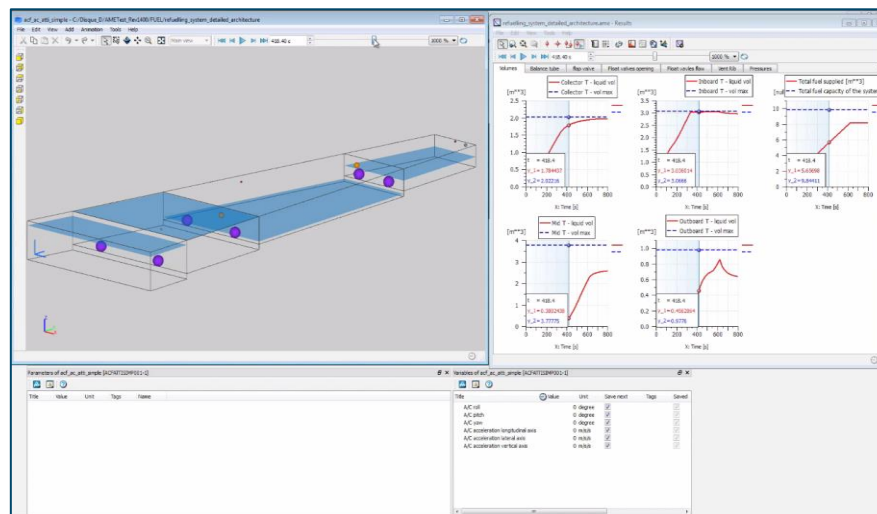

可升级的仿真

连接机械-控制

模型简化  
用于实时



共仿真

开放和定制化

30 多个库

4,000  
多物理模型

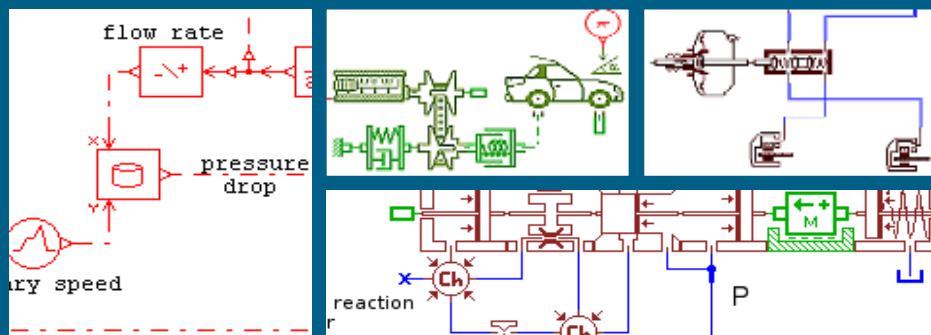

液压  
气动  
热  
电  
机械  
信号

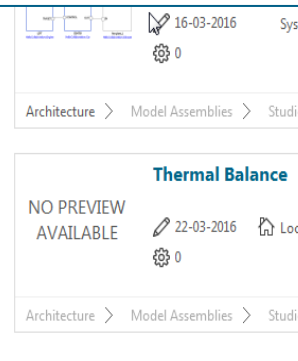

流程和数据管理

# 实时仿真 - 一维, 三维结合 实现人在环(模拟器) - 前置控制工程

SIEMENS



# 应对预测性工程分析的解决方案-- Simcenter™ Portfolio

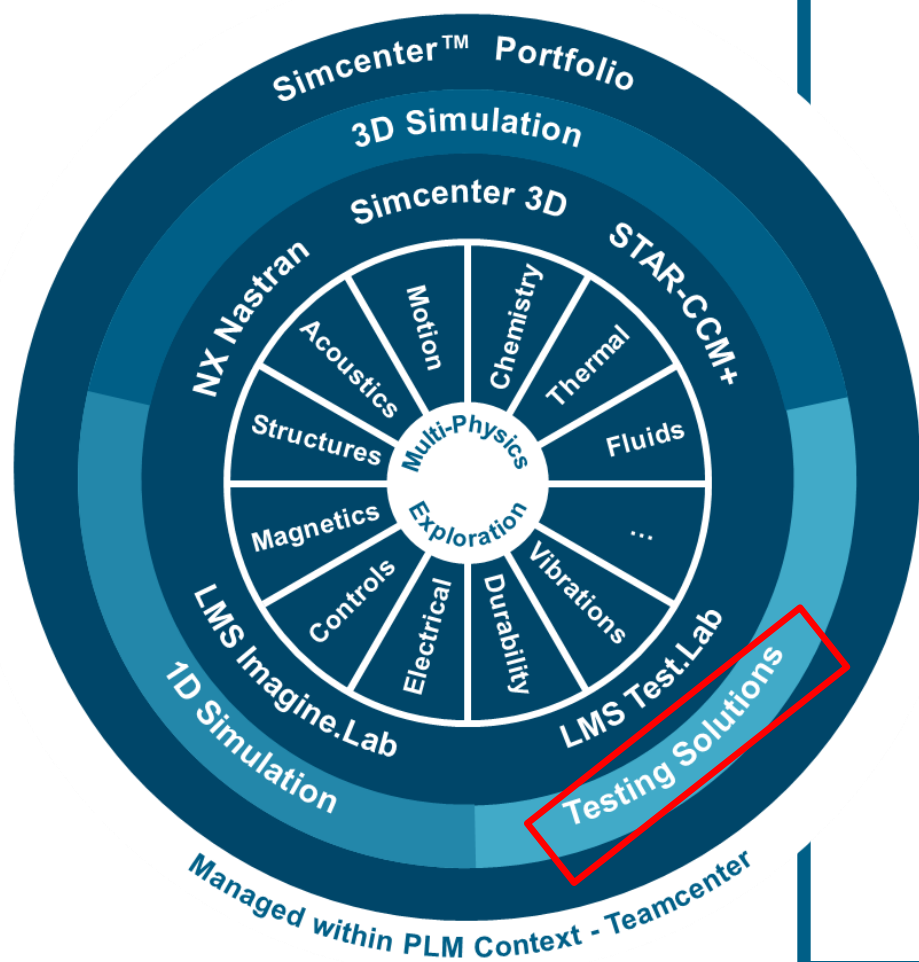

# Simcenter™ 产品测试方案



# Simcenter™ 产品系列用于预测性工程分析 实物测试方案 ( LMS Test.Lab & LMS SCADAS ) -软件和硬件

SIEMENS

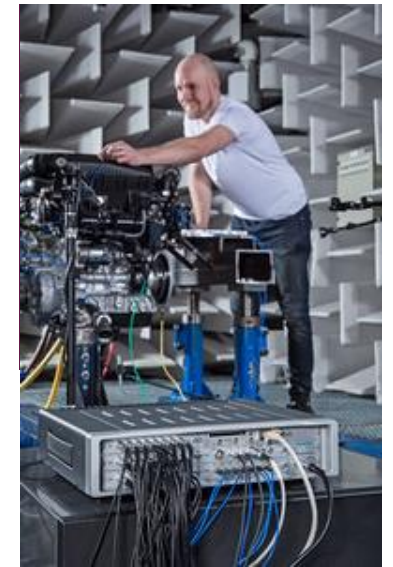
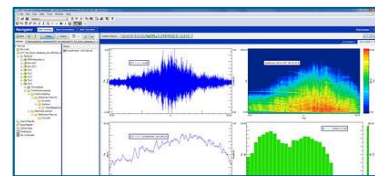
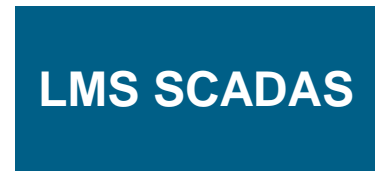
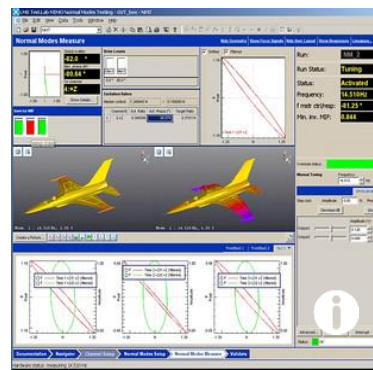
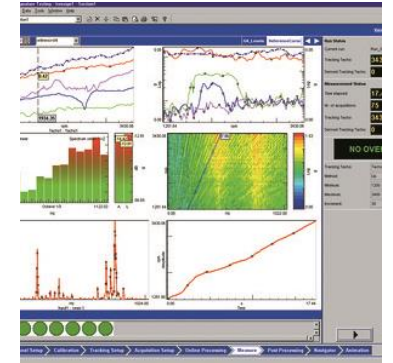
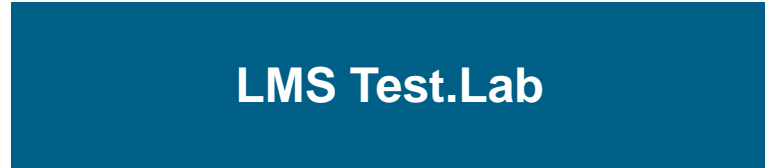
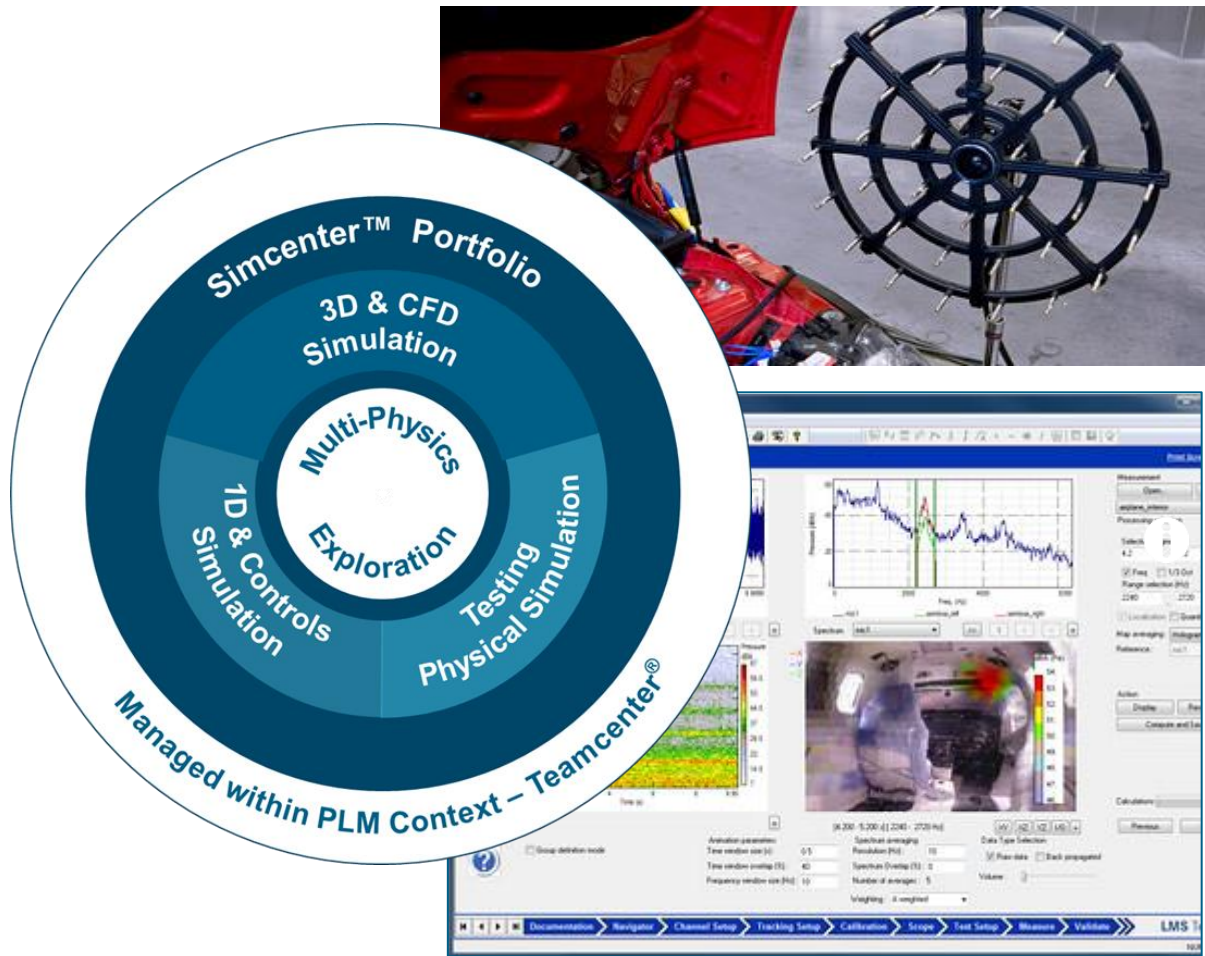

# Simcenter™ 产品系列用于预测性工程分析 LMS Test.Lab & LMS SCADAS

SIEMENS



基于模型的系统测试

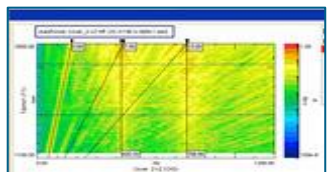
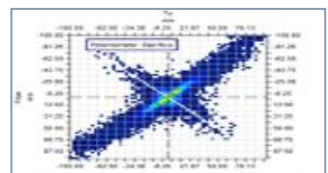

结构  
NVH  
声学  
旋转机械  
疲劳

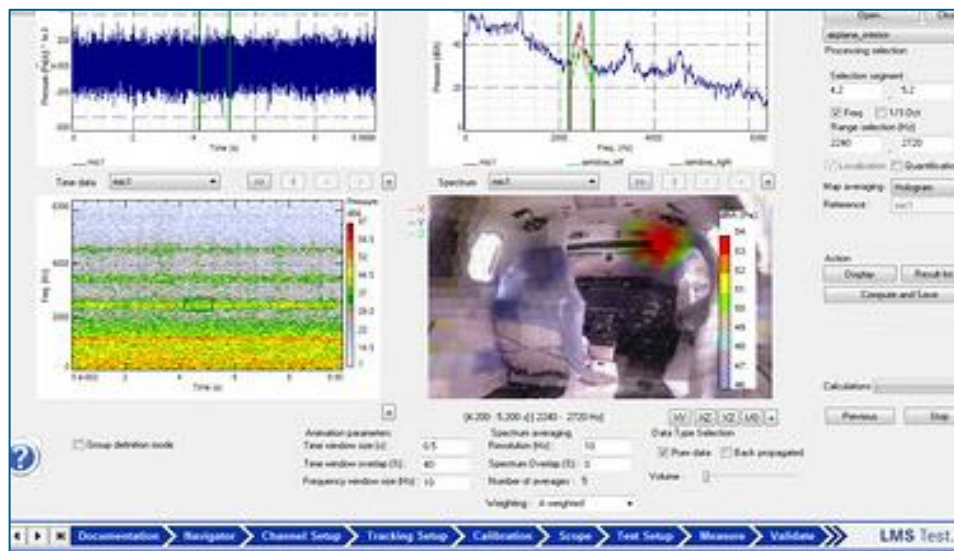

疲劳  
环境测试  
振动控制

TEST-CAE  
相关性

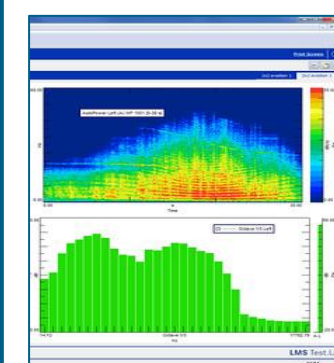

模拟量

- 麦克风
- 应力, 应变
- 位移
- 力, 力矩, 载荷, 压力
- 转速, 电路逻辑
- 温度, 电流



数字量

- GPS
- 图像
- CANBus
- Flexray协议
- 以太网
- 车轮力



# 应对预测性工程分析的解决方案-- Simcenter™ Portfolio

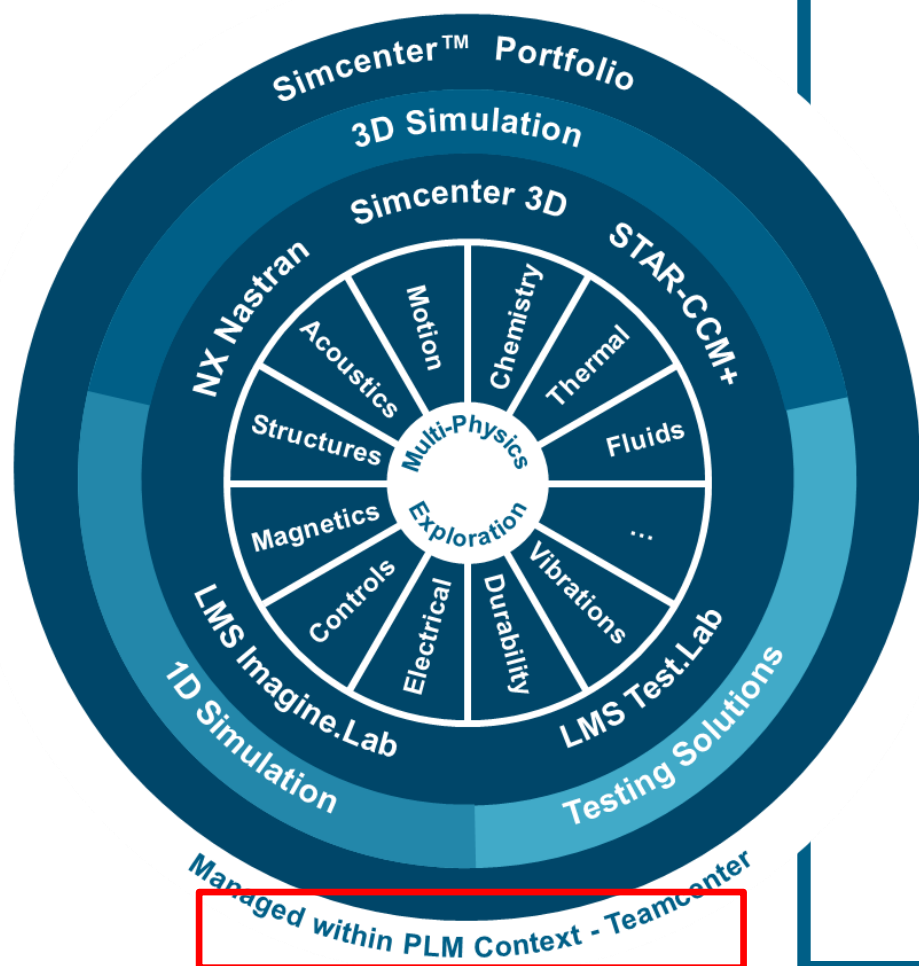

# Simcenter™ 仿真数据管理

# Simcenter™ 产品系列用于预测性工程分析 Teamcenter - 模型和数据管理

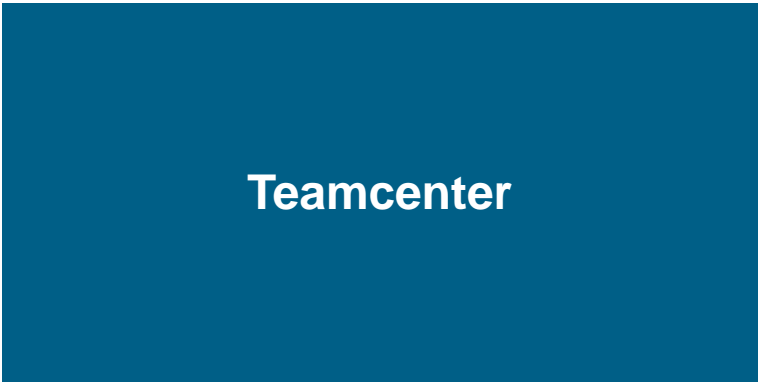
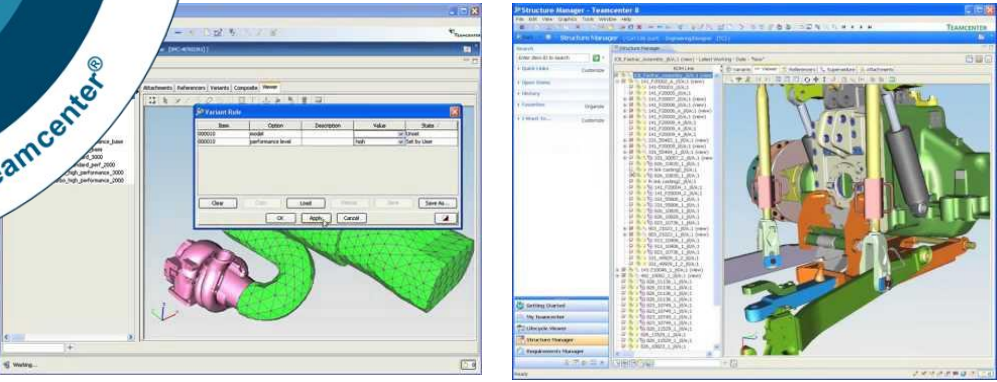
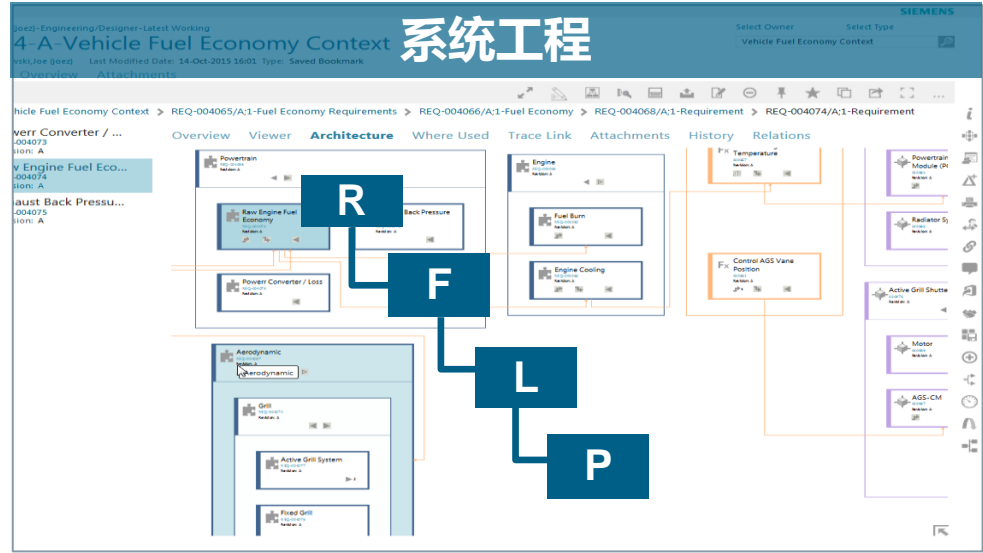
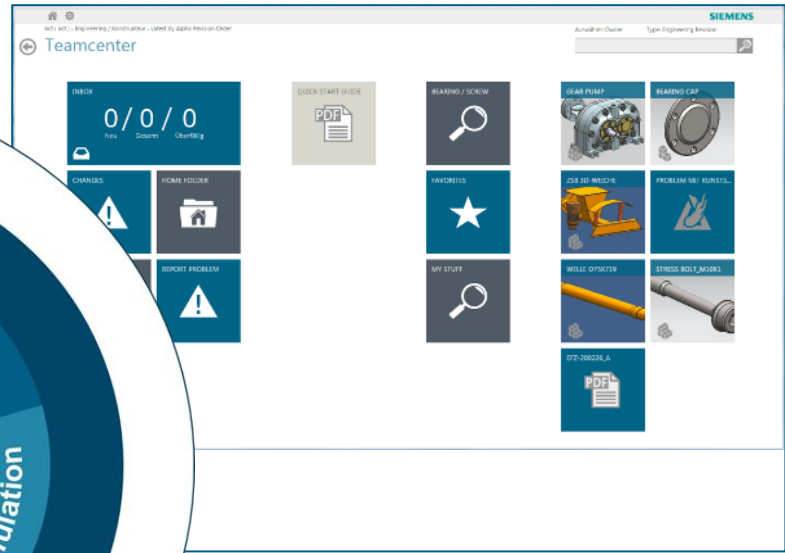
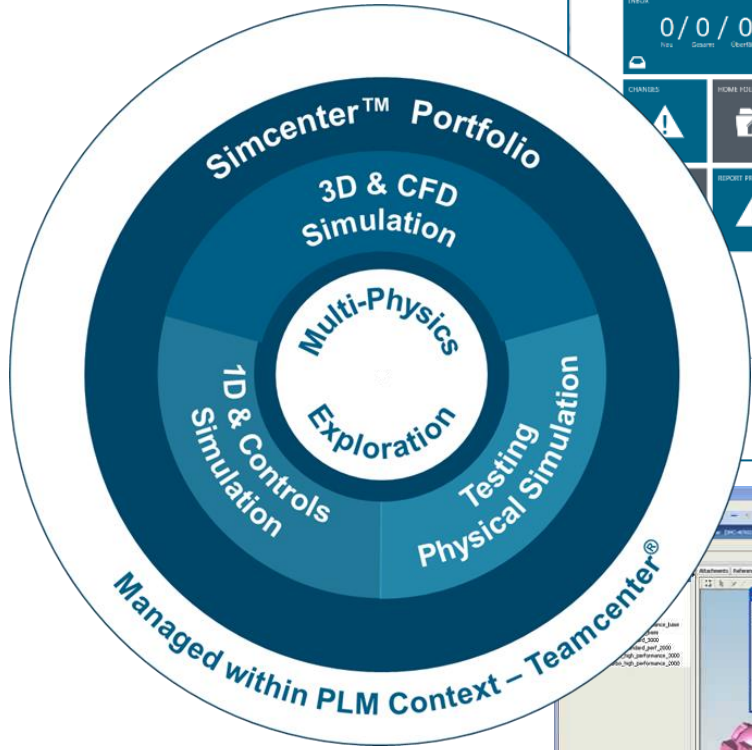

# 总结



# 总结

# Simcenter™ 3D 预测工程分析的先锋队 独一无二的现代3D仿真环境

SIEMENS

## 无与伦比的产品方案组合

- 多学科和多物理场
- 市场领先的求解器
- 覆盖所有的仿真领域, 包括1D耦合以及测试和仿真的相关性
- 联合控制系统, 开展系统级别的机电仿真分析覆盖产品生命周期, 从概念到机测试
- 企业级的知识和仿真数据管理
- 世界范围内的客户已经部署和证明

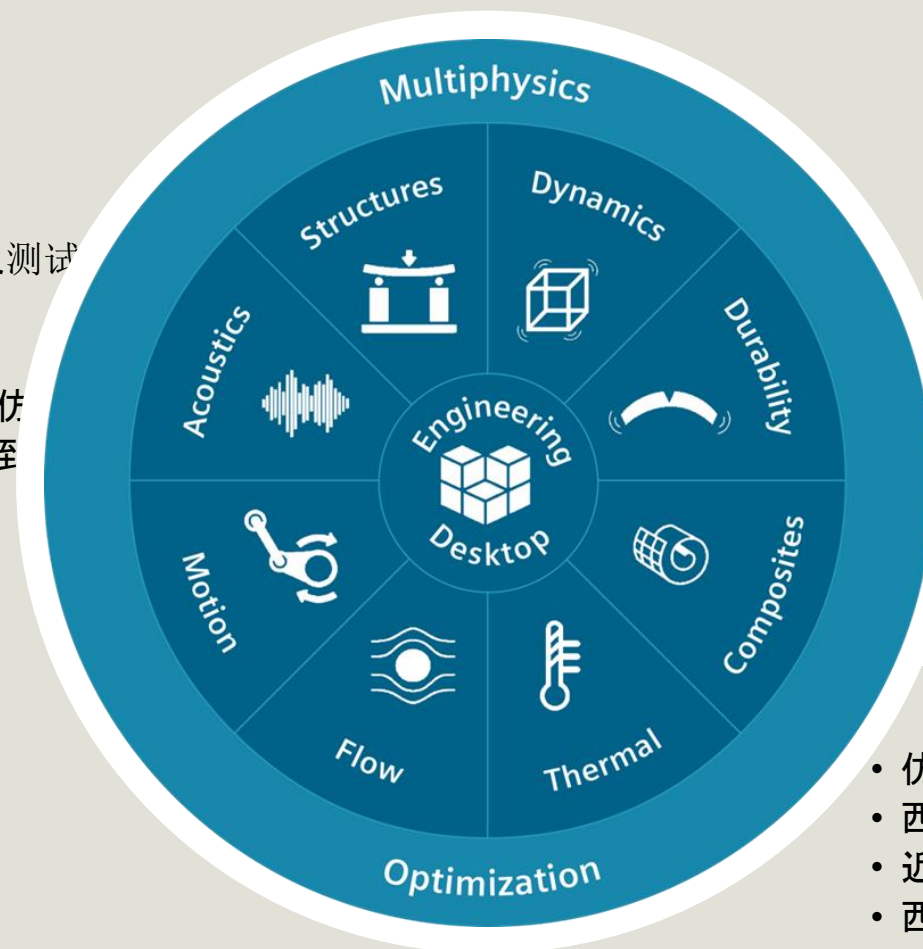

## 开放性和可扩展性

- 支持第三方的方案
- 支持行业标准
- 独特的定制功能

## 行业和工程经验

- 集成的垂直方案
- 工程咨询服务

## 优势和承诺

- 仿真和分析时西门子数字化的战略
- 西门子在仿真和分析市场属于领导者
- 近期超过20亿的投资
- 西门子的行业和财务优势

# Simcenter™ 3D

推动预测工程分析流程的Simcenter™ 产品组合的部分

SIEMENS

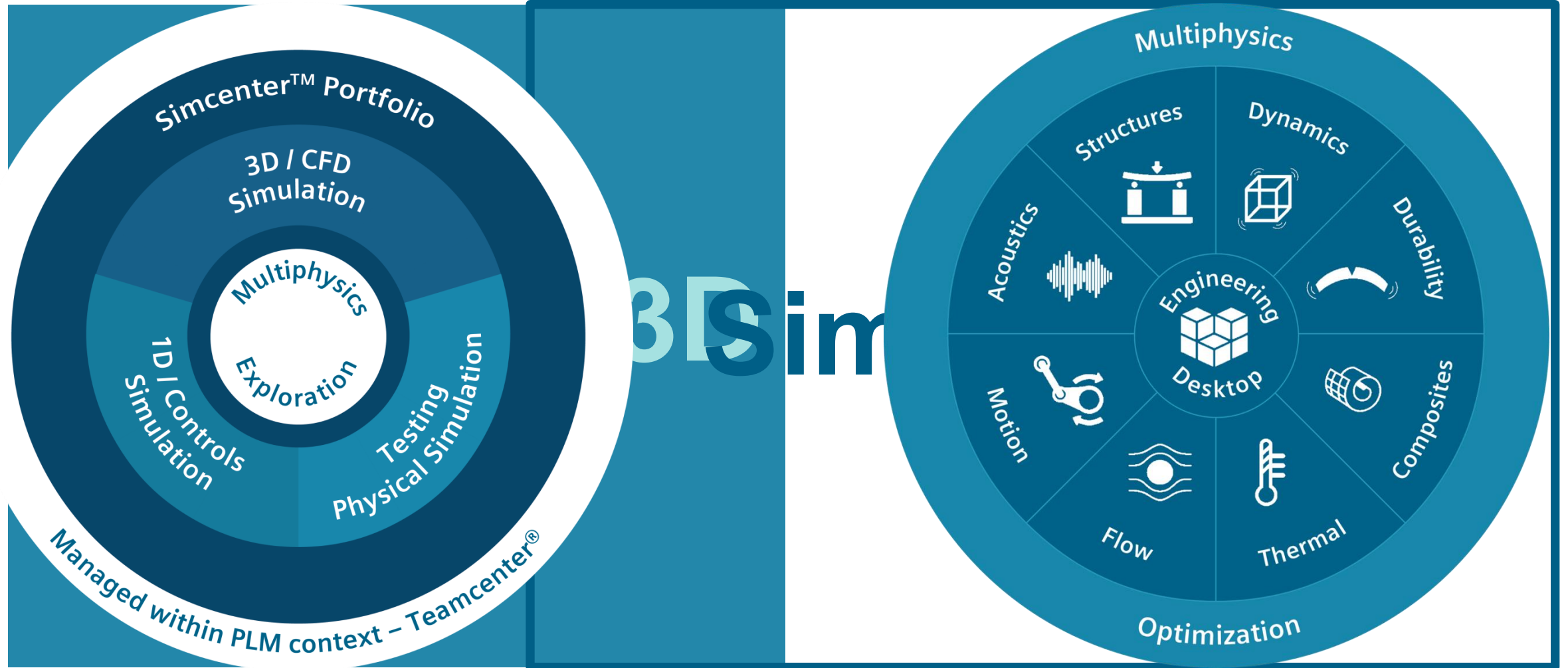



**SIEMENS**  
*Ingenuity for life*

谢谢

Restricted © Siemens AG 2016

Realize innovation.